

SARCON and ZEBRA are registered trademarks of FUJIPOLY

STATEMENT OF LIEU OF WARRANTY: All technical information and data in this document is based on tests and is believed to be accurate and reliable. Nevertheless, since the products described herein are not provided to conform with mutually accepted specifications and the use thereof is unknown, the manufacturer and seller of the product do not guarantee results, freedom from patent infringement, or suitability of the product for any application thereof. The manufacturer and seller of the product described in this document will provide all possible technical assistance and will replace any products proven defective. No statement or recommendation made by the manufacturer or seller not contained herein shall have any force of effect unless in conformity with an agreement signed by an officer of the seller or manufacturer. Product testing by the purchaser is recommended in order to confirm expected results. Copyright© 2022 FUJIPOLY

Supplement of Thermal Conductivity

- Our standard measurement method is Thermal Conductivity by Hot Disk and Thermal Resistance by TIM tester.

Handling Notes

- It is recommended to use the material in up to 30% of compression ratio. Using the material beyond the recommended compression rate may result in excessive silicone oil exudation.
- It is recommended to compress the material with the equal ratio on the whole surface. Partial excessive stress may also result in excessive silicone oil exudation.

Statement of Lieu of Warranty

- Properties of the products may be revised due to some changes for improving performance.
- Properties values in this document are not specification or guaranteed.
- This product is made of silicone, and silicone oil may exude from the product.
- This product is made of silicone, and low molecular siloxane may vaporize depending on operating conditions.
- The product is designed, developed, and manufactured for general industrial use only. Never use for medical, surgical, and/or relating purposes. Never use for the purpose of implantation and/or other purposes by which apart of or whole product remains in human body.
- Before using, a safety must be evaluated and verified by the purchaser.
- Contents described in the document do not guarantee the performances and qualities required for the purchaser's specific purposes. The purchaser is responsible for pre-testing the product under the purchaser's specific.
- Statements concerning possible or suggested uses made herein may not be relied upon, or be constructed, as a guaranty of no patent infringement.

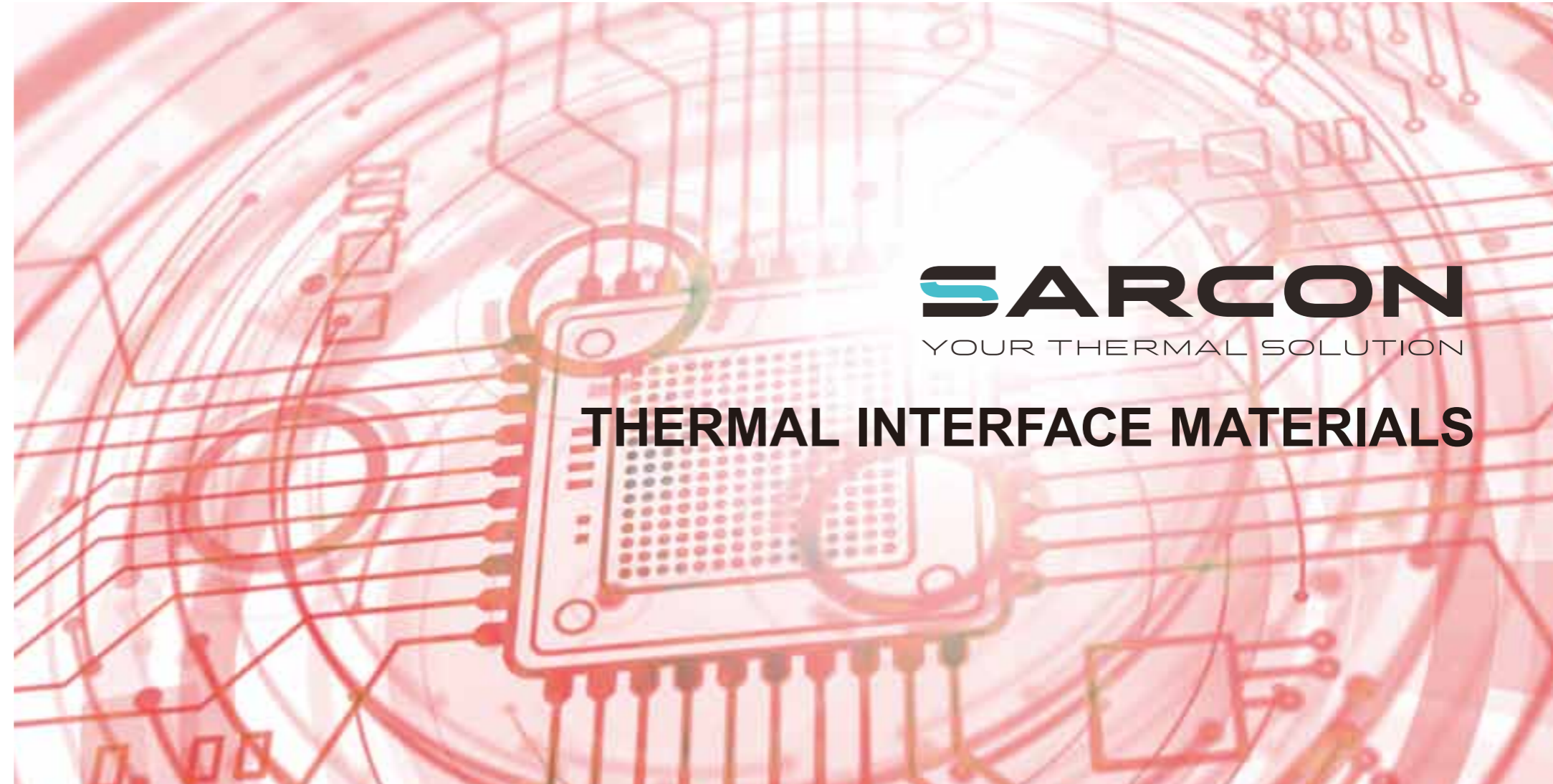

SARCON

YOUR THERMAL SOLUTION

THERMAL INTERFACE MATERIALS



LINE UP

	Construct	Feature	
SARCON RUBBER TYPE	<ul style="list-style-type: none"> • Silicone Rubber • Inorganic Thermal Conductive Filler 	SARCON Rubber Type based materials offer other useful elements such as electrical insulation, protective coverings and gasketing as integral features in most designs.	P. 09 - 16
SARCON GAP FILLER TYPE (GEL SHEET TYPE) SARCON NON-SILICONE GAP FILLER TYPE (NON SILICONE GEL SHEET TYPE)	<ul style="list-style-type: none"> • Silicone Rubber • Inorganic Thermal Conductive Filler • Non-Silicone material ; NR-c 	SARCON Gap Filler Type is supplied in a fully cured state and remain pliable, easily conforming to minute surface irregularities. Therefore SARCON Gap Filler Type can be further enhanced for special handling and die-cutting requirements. SARCON Non-Silicone Type is highly conformable, thermally conductive, acrylate resin (non-silicone) sheet.	P. 17 - 26
SARCON EXTREMELY COMPRESSIBLE GAP FILLER TYPE (PUTTY SHEET TYPE)	<ul style="list-style-type: none"> • Putty like Silicone Rubber • Inorganic Thermal Conductive Filler 	SARCON Extremely Compressible Gap Filler Type is easy to flow and fill gaps with low compression force at high compression rate.	P. 27 - 34
SARCON EM NOISE SUPPRESSION SHEET TYPE	<ul style="list-style-type: none"> • Silicone Rubber • Ferrite • Inorganic Thermal Conductive Filler 	SARCON Silicone Gap Filler Pad for Suppression of Electromagnetic Wave is effective to suppress and damp range of electromagnetic waves, also effective as a high performance thermal interface material.	P. 35 - 36
SARCON FORM IN PLACE GAP FILLER TYPE	<ul style="list-style-type: none"> • Silicone material • Inorganic Thermal Conductive Filler 	SARCON Form in Place Gap Filler Type is highly conformable with very low compression forces. Therefore SARCON Form in Place Gap Filler Type is suitable for filling the delicate gaps and still provide superior thermal transfer.	P. 37 - 38
SARCON NON-SILICONE FORM IN PLACE GAP FILLER TYPE	<ul style="list-style-type: none"> • Non-Silicone Rubber • Inorganic Thermal Conductive Filler 	SARCON Non-Silicone Form in Place Gap Filler Type is highly conformable and highly thermal conductive type silicone free compound with very low compression force.	P. 39
SARCON GREASE TYPE	<ul style="list-style-type: none"> • Silicone material ; SG 07SL/SG 26SL • Non-Silicone material ; SG 07NS/SG 26NS/SG 42NS • Inorganic Thermal Conductive Filler 	SARCON Grease Type ensure the lowest amount of bleed and evaporation.	P. 40

CONTENTS

Introduction	P. 01 - 04	Volatile Components of SARCON series	P. 41	
Product Application Examples	P. 05 - 06	Silicone Oil Content of SARCON series	P. 42	
SARCON Selection Guide	P. 07 - 08	Outgassing and Total Mass Loss of SARCON series	P. 42	
Products	• Typical Product Properties	P. 09 - 40	TEST Method	P. 43 - 46
	• Construction		FUJIPOLY Technology	P. 47 - 49
	• Thermal Resistance		Locations	P. 50
	• Compression Force			
	• Thermal Resistance Data			
	• Reliability of SARCON materials			
	• Relaxing Compression Force versus Thermal Resistance			
	• Thickness of SARCON materials			

Thermally Conductive / Non-Flammable Silicone Rubber

SARCON

Our unique product, SARCON is an advanced silicone rubber with high thermal conductivity and superior flame retardancy.



SARCON's versatility in thermal management applications is doubly enhanced by way of the variety of end-use configurations possible, and the many standard material formulations available in each. The silicone rubber based materials offer other useful elements such as electrical insulation, protective coverings and gasketing as integral features in most designs. Along with a few simple recommendations to help in obtaining the optimum performance for your application, a few suggestions are included which may help you to take advantage of some of these other features.

Functions

As shown below, even the most highly polished mating surfaces do not make reliable contact surfaces. Complete physical contact is necessary to minimize the resistance to heat flow for the best thermally conductive path. Such surface voids, when properly filled with a conformable, SARCON, will in most cases exhibit the continuous characteristics of a solid metal of the same dimensions.

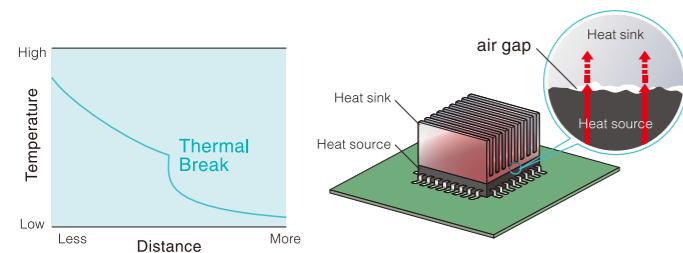

Thermal resistance of semiconductor mounted to substrate is appreciably increased at junction of porous surfaces.

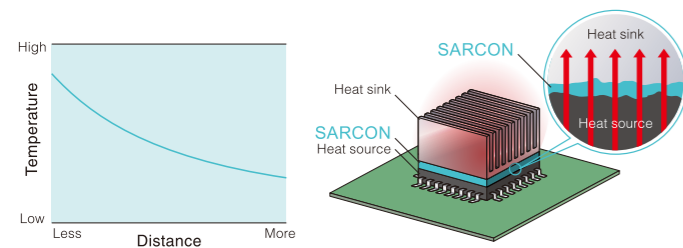

Thermal resistance of semiconductor mounted to substrate with gap filler pad is eliminated yielding higher temperature gradient.

Flame Retardant

UL File Number: E58126

Applications

- Thermal conductive insulators for semiconductors
- Compression jointing materials for thermistors and temperature sensors
- Thermal conductive material for all types of heaters

Formulations/Configurations

- A variety of specific compounds are available for a wide range of performance requirements in Sheets, Rolls, Die-cuts, Sleeves, Gel, Extrusions, Moldings



More power and light weight. In the past, these two characteristics in electronics were mutually exclusive. Now, micro-electronics are just that, and in addition, need thermal management components to further complement these objectives. SARCON is an advanced silicone rubber with high thermal conductivity and superior flame-retardancy. By combining the inherent silicone rubber properties of heat resistance, electrical insulation and long-term aging into one compound, this universally applicable material can be made in an unlimited number of thermal management configurations.

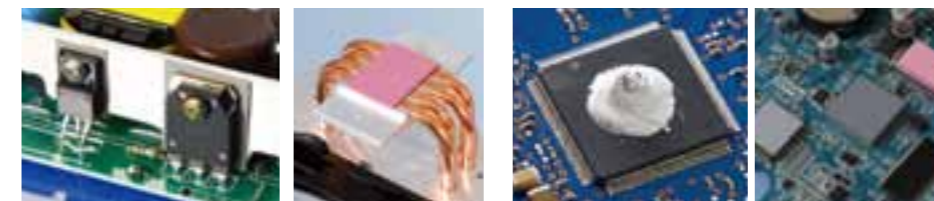

- a.) No special preparations are necessary to attach the SARCON component.
- b.) Some of the most common alternatives include:
 - Pressure Sensitive Adhesive
 - Silicone Adhesive
 - Mechanical Clamping
 - Hardware Attachment / Screws, rivets
 - Self-Adhering Silicone Gel

THERMAL TRANSFER

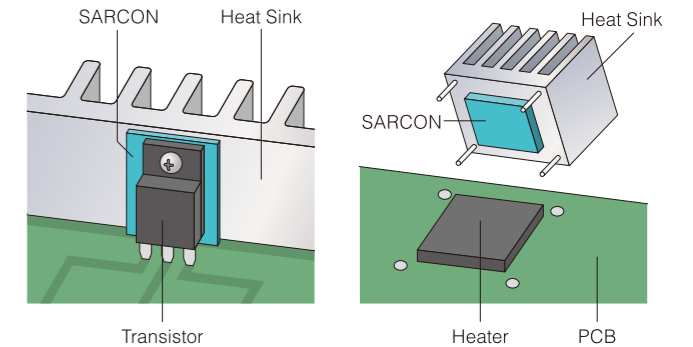

- a.) Consider the most efficient SARCON materials regarding thermal conductivity.
- b.) Take advantage of the heat transfer characteristics of any nearby sheet metal, heat sink and case components by using the SARCON component as a thermally conductive bridge from Heater to Heat Sink. See drawing at left.
- c.) Note also that SARCON is very elastic, providing a very tight fit over uneven surfaces. This eliminates the need for gap-filling agents in order to achieve high rates of thermal dissipation without variation. The sleeves and cases can be designed as an interface fit which can slip snugly over appropriately configured components.

How to Choose SARCON (Tips)

Thermal conduction can be expressed by Fourier's law of heat conduction.

Here are some tips to improve the heat transfer in your design:

- An interface material with higher thermal conductivity is better.
- It is better that the thickness (distance) of the material is thin (short).
- It is better to have a large surface area.

Following these tips will help achieve efficient heat transfer. Several material options are available to accommodate other application conditions. Please contact FUJIPOLY to help choose your SARCON material.

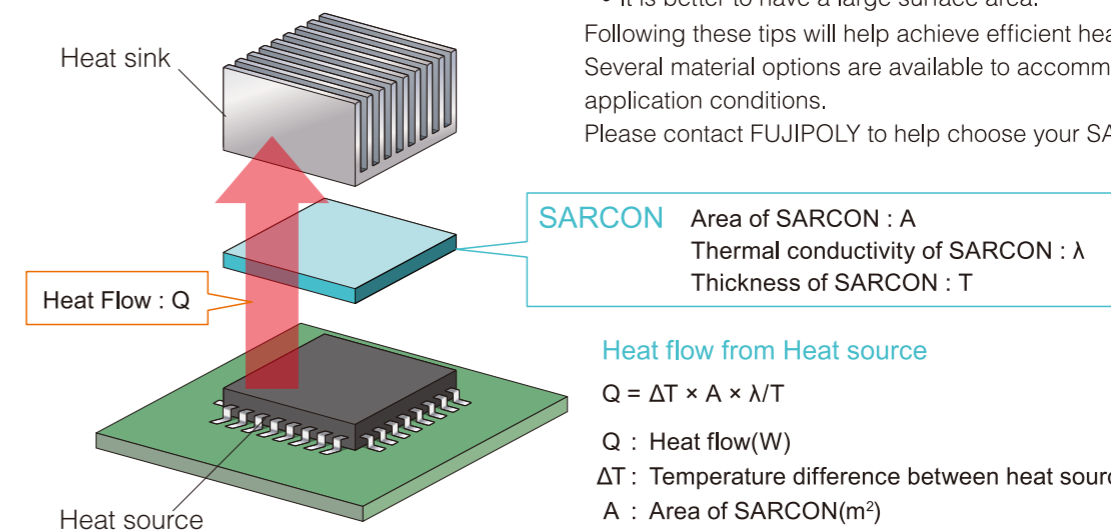

Heat flow from Heat source

$$Q = \Delta T \times A \times \lambda / T$$

Q : Heat flow(W)

ΔT : Temperature difference between heat source and heat sink(K)

A : Area of SARCON(m²)

λ : Thermal conductivity of SARCON(W/m-K)

T : Thickness of SARCON(m)

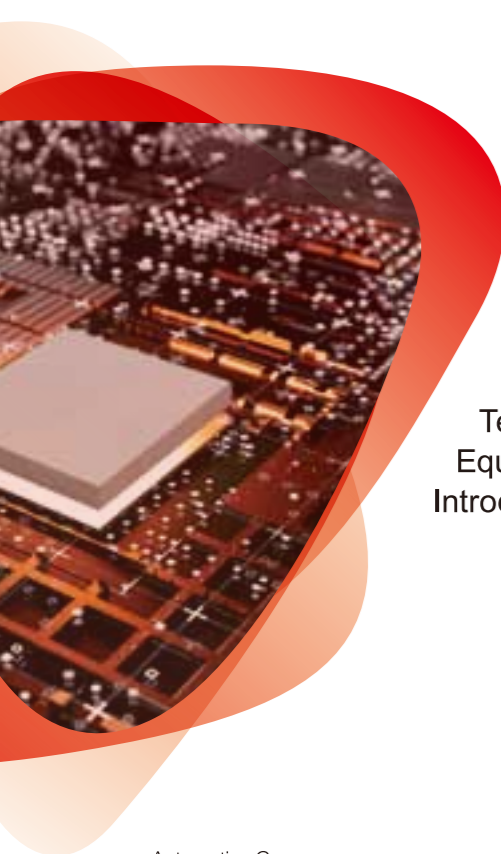

Product Application

SARCON has been used for many years in Automobile, Telecommunication Equipment, Consumer and Industrial Equipment, etc. Introducing some examples of its use.

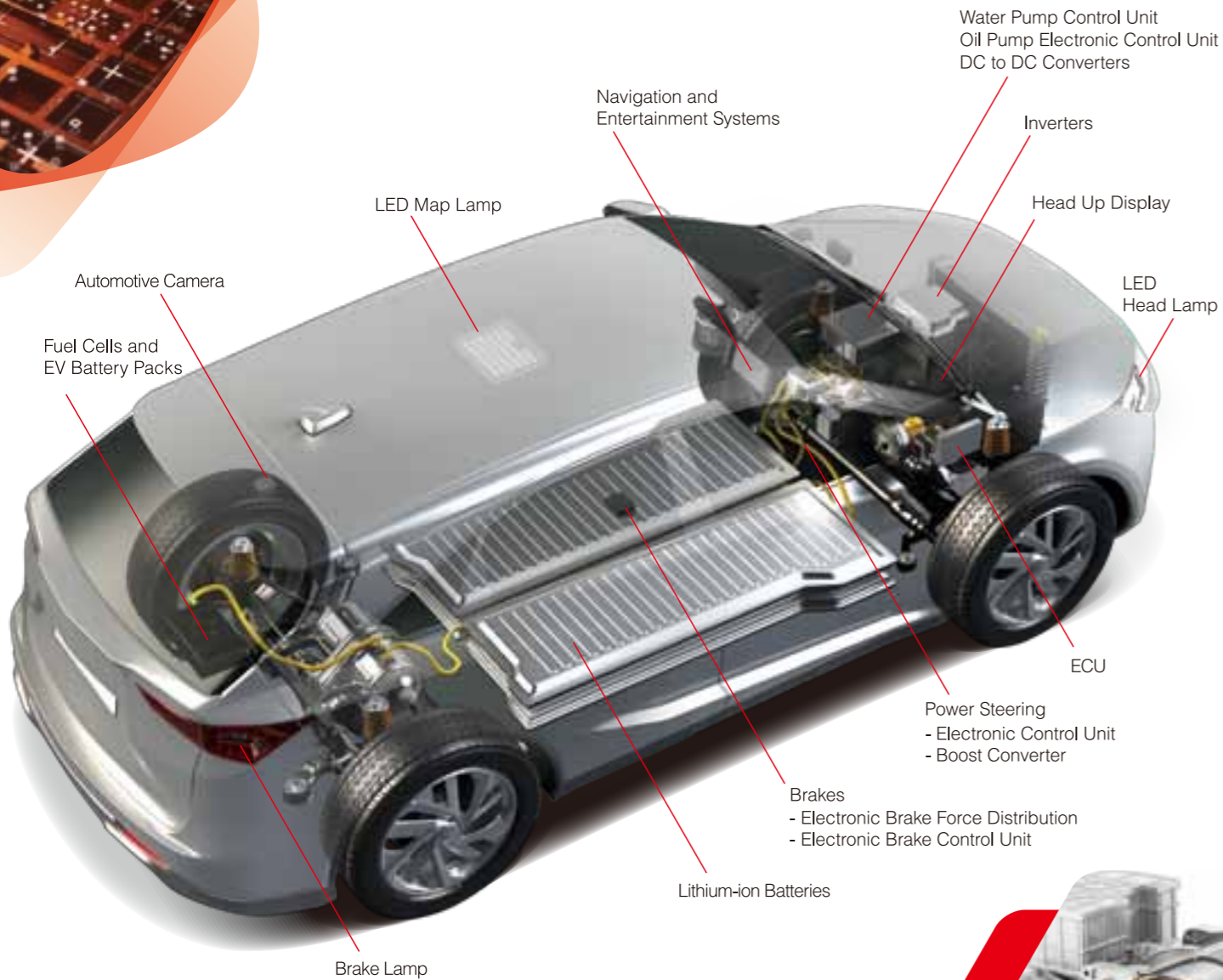

Automobile

- Lithium-ion Battery • Camera • LED Head Lamp
- Infotainment • General ECU etc.

In the ever-evolving technological innovation, FUJIPOLY will contribute to society with many years of achievements for automobiles and our products.



Consumer and Industrial Equipment

- TV, Game Console, BD Player, Projector, Printer, Digital Camera
- LED Lighting, Air Conditioner, Microwave Oven, Refrigerator
- Robot, Power Conditioner, Factory Automation Equipment
- Train, Motorcycle, Drone, Airplane etc.

In consumer and industrial equipment that makes our lives comfortable, our excellent technical capabilities are utilized.



Telecommunication Equipment

- Optical Transceiver • Base Station
- Communication Device • Server etc.

The evolution of telecommunication equipment is accelerating, and various needs are increasing. FUJIPOLY will contribute to problem solving according to the speed of evolution.



SARCON Selection Guide

Test Method : Thermal Conductivity (W/m-K)

SARCON Thermal Conductivity List

Thermal Conductivity (W/m-K)	RUBBER TYPE	GAP FILLER TYPE	EXTREMELY COMPRESSIBLE GAP FILLER TYPE	EM NOISE SUPPRESSION SHEET TYPE	FORM IN PLACE GAP FILLER TYPE
0.8				EGR-11F	
0.9	GTR				
1.2	TR				
1.3		NR-c (NON-SILICONE TYPE)			
1.4	GHR	GR14B			
1.7	HR				
2.1					SPG-20B
2.2	YR-a				
2.5		GR25B	PG25A		SPG-25B-NS (NON-SILICONE TYPE)
3.0	GAR			EGR30A	
3.1					SPG-30B
3.4	YR-d <small>Hot Disk method</small>				
4.5		GR45A	PG45A GR-Pm		
5.0					SPG-50A
7.0					SPG-70A
8.0		GR80A	PG80B		
10.0		GR100A			
13.0		GR130A	PG130A		

Measured by using Hot Disk method, refer to FUJIPOLY Test method "FTM P-1612". → See P.43
Rubber Type : Measured by using Hot Wire method, refer to FUJIPOLY Test method "FTM P-1620". → See P.43

Thin film with high electric isolation
RUBBER TYPE

Hot Wire : 1.2	TR	P. 09-16
Hot Wire : 1.7	HR	
Hot Wire : 2.2	YR-a	
Hot Disk : 3.4	YR-d	

Thin film with high electric isolation and high mechanical strength
RUBBER TYPE
within Glass Fiber Cloth

Hot Wire : 0.9	GTR	P. 09-16
Hot Wire : 1.4	GHR	
Hot Wire : 3.0	GAR	

Thin or middle thickness with wider gap's variation and low thermal resistance
GAP FILLER TYPE (GEL SHEET TYPE)

Hot Disk : 1.4	GR14B	P. 17-26
Hot Disk : 2.5	GR25B	
Hot Disk : 4.5	GR45A	
Hot Disk : 8.0	GR80A	
Hot Disk : 10.0	GR100A	
Hot Disk : 13.0	GR130A	

Thin or middle thickness with Non-Silicone Pad
NON-SILICONE GAP FILLER TYPE (NON-SILICONE GEL SHEET TYPE)

Hot Disk : 1.3	NR-c	P. 17-26
----------------	------	----------

For wider gaps with better compressibility
EXTREMELY COMPRESSIBLE GAP FILLER TYPE (PUTTY SHEET TYPE)
Highly Thermally Conductive and Non-Flammable interface materials

Hot Disk : 2.5	PG25A	P. 27-34
Hot Disk : 4.5	PG45A	
Hot Disk : 4.5	GR-Pm	
Hot Disk : 8.0	PG80B	
Hot Disk : 13.0	PG130A	

To suppress and damp range of electromagnetic waves
EM NOISE SUPPRESSION SHEET TYPE

Hot Disk : 0.8	EGR-11F	P. 35-36
Hot Disk : 3.0	EGR30A	

For wider gaps with better compressibility
FORM IN PLACE GAP FILLER TYPE

Hot Disk : 2.1	SPG-20B	P. 37-38
Hot Disk : 3.1	SPG-30B	
Hot Disk : 5.0	SPG-50A	
Hot Disk : 7.0	SPG-70A	

Highly Thermally Conductive and Electrically Insulative Silicone free Compound
NON-SILICONE FORM IN PLACE GAP FILLER TYPE

Hot Disk : 2.5	SPG-25B-NS	P. 39
----------------	------------	-------

Minimum thickness (Silicone and Non-Silicone formulations)
GREASE TYPE

ASTM D5470 : 0.75 to 4.2	SG-SL / SG-NS	P. 40
--------------------------	---------------	-------

ASTM D5470: Measured by ASTM D5470 modified, refer to FUJIPOLY Test method "FTM-P3030". → See P.44

SARCON RUBBER TYPE

Thin Film with High Heat Conducting and High Electric Insulation

SARCON Rubber type developed by our original studies are the epoch-making silicone rubber products with high insulative and thermally conductive properties as well as a high flame resistant or non flammable property.

Features

- Has a thermal conductivity and excellent electrical insulation properties.
- Available for Tubes, Tapes, Cases and Die-cut Gaskets shapes to meet a various application (Shown on Page10 of Configuration).
- GTR, GHR ; Heat conductive silicone rubber within Glass Fiber Cloth has excellent mechanical and physical characteristics.
- UL94 V-0.
- Available with an Adhesive option.



Recommended Application

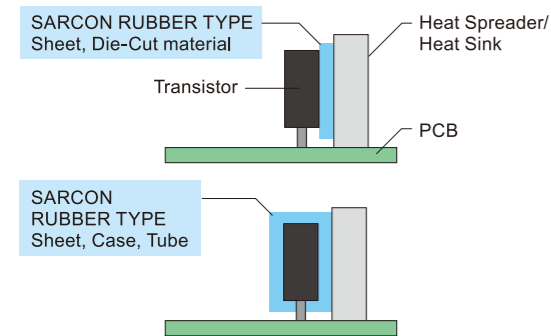

- Attachment
- pressure sensitive adhesive
 - silicone adhesive
 - mechanical clamping
 - hardware attachment - screw, rivets

Pressure versus Thermal resistance

- Thermal resistance decrease as the pressure is increased.
- Test method : FUJIPOLY Test Method "FTM P-3070"

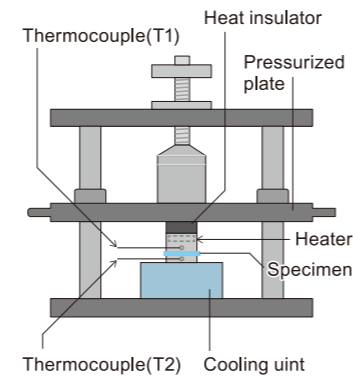
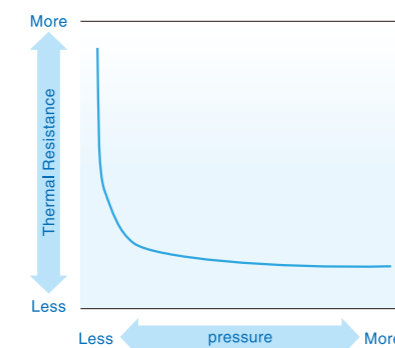

Configuring a Part Number of Rubber Type

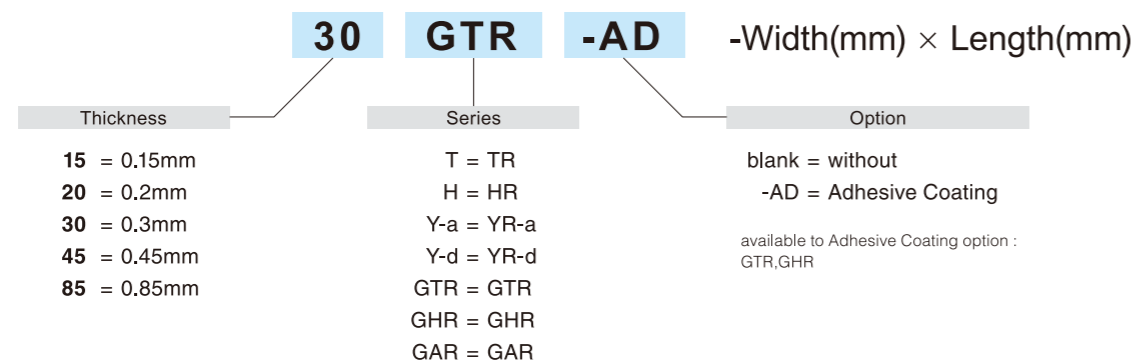

Configuration

SARCON RUBBER TYPE's versatility in thermal management applications is doubly enhanced by way of the variety of end-use configurations possible, and the many standard material formulations available in each.

The silicone rubber based materials offer other useful elements such as electrical insulation, protective covering and gasketing as integral features in most designs.

	Color	Form				Hardness (IRHD)	Thermal Conductivity (W/m-k) by using Hot Wire
		Tape	Sheet	Tube	Case		
GTR	Greenish Gray	○	○	×	×	87 (20GTR)	0.9
TR	Greenish Gray	○	×	○	○	75	1.2
GHR	Brown	○	○	×	×	92 (20GHR)	1.4
HR	Brown	○	×	○	○	85	1.7
YR-a	Dark Gray	○	×	○	×	85-89	2.2
GAR	White	○	○	×	×	80 (20GAR)	3.0
YR-d	Gray	○	×	×	×	70-76	3.4 (Hot Disk method)

Tube



Tube shapes available in three thicknesses. The flexible structures conform to most applications. All standard items in stock; custom lengths and diameters available.

Tape



Flat stock in rolls or single sheets for your custom finishing. Can be diecut or trimmed to any proprietary shape on your finishing equipment.

Case



Box-shaped caps for transistors. High thermal dissipation rate. Open on one end; installs by just slipping over the desired components.

Die-cut Gaskets



Standard die-cut parts. Effective also as a mounting cushion to prevent deformation. Customs designs available in unlimited sizes and shapes.

Custom - Rubber Extrusions

SARCON E Mold products are co-extruded products of highly thermally conductive and non-flammable silicone rubber, SARCON, and available in various shapes and designs.

Refer to P.47

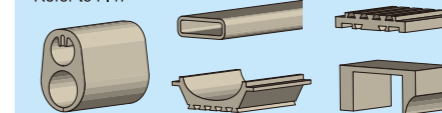

AD series

Available to Adhesive Coating option:



Construction

TR / HR / YR-a / YR-d

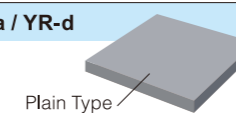

GTR / GHR / GAR

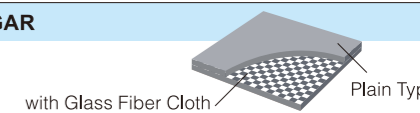

Typical Product Properties

Test Properties	Unit	GTR			TR				GHR			HR			YR-a				GAR			YR-d			Test Method		
		15GTR	20GTR	30GTR	20T	30T	45T	85T	15GHR	20GHR	30GHR	30H	45H	85H	20Y-a	30Y-a	45Y-a	85Y-a	20GAR	30GAR	45GAR	20Y-d	30Y-d	45Y-d			
Adhesive Coating	-	Available			Request				Available			Request			Request				None			Request			-		
Reinforcement	-	Glass Fiber Cloth			None				Glass Fiber Cloth			None			None				Glass Fiber Cloth			None			-		
Thickness	mm	0.15	0.2	0.3	0.2	0.3	0.45	0.85	0.15	0.2	0.3		0.3	0.45	0.85	0.2	0.3	0.45	0.85	0.2	0.3	0.45	0.2	0.3	0.45	ASTM D374	
Specific Gravity	-	2.2	2.2	2.2	2.3	2.3	2.3	2.3	2.4	2.4	2.4		2.4	2.4	2.4	2.6	2.6	2.6	2.6	2.9	2.9	2.9	2.7	2.7	2.7	ASTM D792	
Hardness	IRHD	87	87	92	74	75	75	75	92	92	95		85	85	85	85	86	89	87	80	87	87	70	76	74	IRHD / ISO 7619	
Color	-	Greenish Gray			Greenish Gray				Brown			Brown			Dark Gray				White			Gray			Visual		
Tensile Strength	MPa	71.9	53.9	30.8	4.7	4.8	5.0	4.8	52.3	39.2	22.4		4.8	5.0	5.0	14.2	4.5	4.6	4.0	47.5	23.2	21.8	2.4	2.4	2.4	ASTM D412 / 1458	
	psi	10,426	7,816	4,466	682	696	725	696	7,583	5,684	3,248		696	725	725	2,059	652	667	580	6,888	3,364	3,161	354	354	345		
Elongation	%	2 or less	2 or less	2 or less	78	100	100	100	2 or less	2 or less	2 or less		60	60	60	50	73	80	80	3 or less	3 or less	3 or less	73	76	75	ASTM D412 / 1458	
Volume Resistivity	Ohm-m	1x10 ¹³	1x10 ¹³	1x10 ¹³	1x10 ¹³	1x10 ¹³	1x10 ¹³	1x10 ¹³	1x10 ¹³	1x10 ¹³	1x10 ¹³		1x10 ¹³	1x10 ¹³	1x10 ¹³	1x10 ¹²	1x10 ¹³	1x10 ¹³	1x10 ¹³	0.7x10 ¹¹	1.1x10 ¹¹	1.7x10 ¹¹	3x10 ¹¹	3x10 ¹¹	1x10 ¹¹	ASTM D257	
Breakdown Voltage	kV(AC)	4	6	8	9	10	11	15	3	6	9		9	10	14	6	10	11	14	10	11	12	6	11	13	ASTM D149	
Dielectric Strength	kV(AC)	4	6	7	6	7	8	10	2	4	8		6	7	10	3	7	8	10	9	9	9	6	9	11	ASTM D149	
Dielectric Constant	-	50Hz	2.5	3.2	3.5	-	4.4	4.5	4.9	3.0	3.3	3.9		4.9	4.6	5.4	-	6.2	6.3	6.0	2.4	3.4	4.0	11.8			ASTM D150
		1kHz	2.5	3.2	3.5	-	4.4	4.5	4.9	3.0	3.3	3.9		4.9	4.5	5.7	-	5.8	5.9	5.7	2.4	3.3	3.9	10.4			
		1MHz	2.5	3.2	3.5	-	4.4	4.5	4.9	3.0	3.3	3.9		4.8	4.5	5.4	-	5.6	5.7	5.4	2.4	3.3	3.9	9.2			
Dissipation Factor	-	50Hz	0.008	0.007	0.007	-	0.004	0.004	0.003	0.015	0.009	0.006		0.008	0.007	0.004	-	0.030	0.030	0.028	0.032	0.026	0.021	0.061			ASTM D150
		1kHz	0.004	0.003	0.003	-	0.002	0.002	0.002	0.005	0.003	0.003		0.004	0.004	0.002	-	0.025	0.025	0.023	0.007	0.007	0.006	0.047			
		1MHz	0.004	0.004	0.003	-	0.003	0.003	0.003	0.003	0.003	0.004	0.004		0.003	0.003	0.002	-	0.010	0.010	0.010	0.003	0.004	0.003	0.027		
Thermal Conductivity	W/m-K	Hot Wire	0.9			1.2				1.4			1.7			2.2				3.0			-			ASTM D2326	
		Hot Disk	-			-				-			-			-				-			3.4			ISO 22007-2	
Recommended Operating Temp.	°C	-40 to +150			-40 to +150				-40 to +150			-40 to +150			-40 to +150				-40 to +150			-40 to +150			-		
	°F	-40 to +302			-40 to +302				-40 to +302			-40 to +302			-40 to +302				-40 to +302			-40 to +302			-		
Flame Retardant	-	V-0			V-0				V-0			V-0			V-0				V-0			V-0			UL94		

a) Some details of thickness → See P.15
 b) Hardness : The highest value by using IRHD.
 c) Thermal Conductivity : Measured by using Hot Disk method, refer to FUJIPOLY Test method "FTM P-1612". → See P.43
 d) Tensile Strength / Elongation on TR , HR , YR-a , YR-d , according to ASTM D412.
 e) Tensile Strength / Elongation on GTR , GHR , GAR according to ASTM D1458, Fully Cured Silicone Rubber - Coated Glass Fiber Cloth.

Pressure versus Thermal Resistance

unit : K-cm²/W (K-in²/W)

Pressure	GTR			TR			GHR			HR			YR-a				GAR			YR-d		
	15GTR	20GTR	30GTR	30TR	45TR	85TR	15GHR	20GHR	30GHR	30HR	45HR	85HR	20Y-a	30Y-a	45Y-a	85Y-a	20GAR	30GAR	45GAR	20Y-d	30Y-d	45Y-d
1.5MPa	1.83 (0.28)	2.70 (0.41)	4.19 (0.64)	3.89 (0.60)	5.24 (0.81)	8.86 (1.37)	1.31 (0.20)	1.78 (0.27)	2.81 (0.43)	2.63 (0.40)	3.15 (0.48)	5.67 (0.87)	1.35 (0.20)	2.01 (0.31)	2.50 (0.38)	4.28 (0.66)	1.27 (0.19)	1.74 (0.26)	2.09 (0.32)	1.00 (0.15)	1.44 (0.22)	1.70 (0.26)
2.5MPa	1.77 (0.27)	2.64 (0.40)	4.10 (0.63)	3.89 (0.60)	5.14 (0.79)	8.64 (1.33)	1.26 (0.19)	1.70 (0.26)	2.73 (0.42)	2.61 (0.40)	3.13 (0.48)	5.66 (0.87)	1.34 (0.20)	2.04 (0.31)	2.44 (0.37)	4.24 (0.65)	1.24 (0.19)	1.67 (0.25)	2.01 (0.31)	1.00 (0.15)	1.46 (0.22)	1.62 (0.25)
3.6MPa	1.70 (0.26)	2.57 (0.39)	4.01 (0.62)	3.67 (0.56)	4.80 (0.74)	8.01 (1.24)	1.15 (0.17)	1.63 (0.25)	2.65 (0.41)	2.52 (0.39)	3.01 (0.46)	5.35 (0.82)	1.26 (0.19)	1.93 (0.29)	2.41 (0.37)	4.07 (0.63)	1.12 (0.17)	1.58 (0.24)	1.92 (0.29)	0.94 (0.14)	1.38 (0.21)	1.56 (0.24)

f) Measured by using FUJIPOLY Original, refer to FUJIPOLY Test method "FTM P-3070". → See P.45

Thermal Resistance Data

Pressure : 1.5MPa

RUBBER TYPE

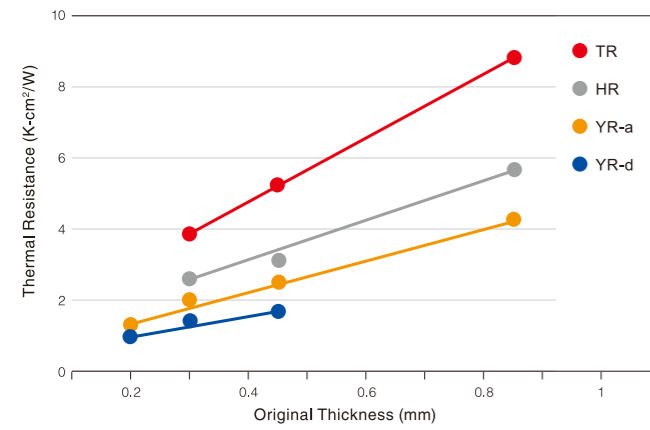

RUBBER TYPE within Glass Fiber Cloth

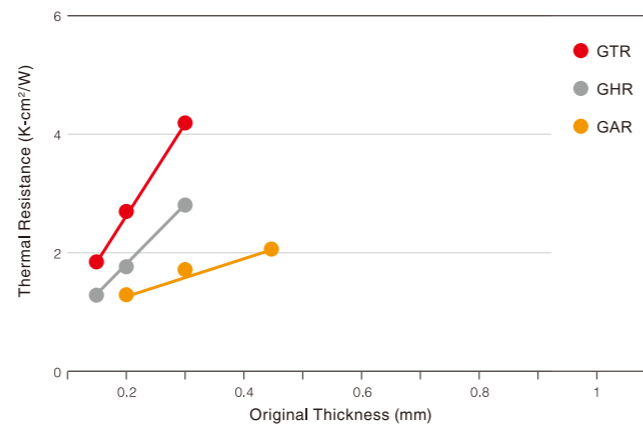

Pressure : 2.5MPa

RUBBER TYPE

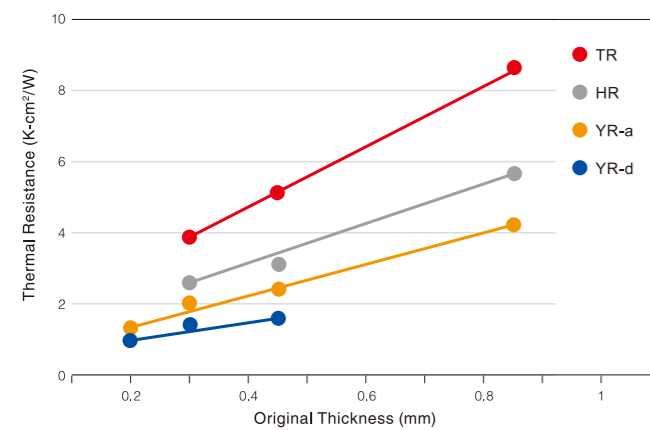

RUBBER TYPE within Glass Fiber Cloth

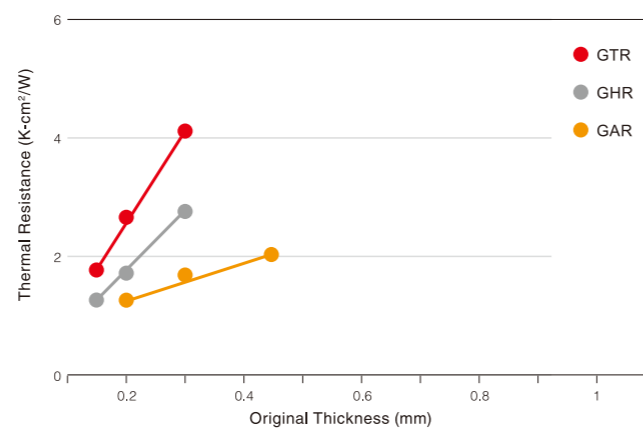

Pressure : 3.6MPa

RUBBER TYPE

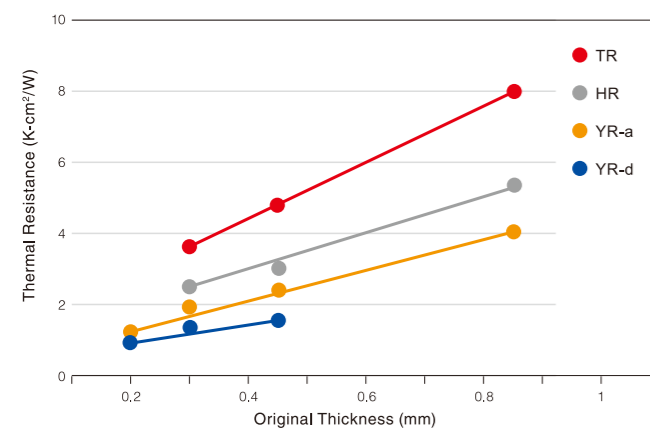

RUBBER TYPE within Glass Fiber Cloth

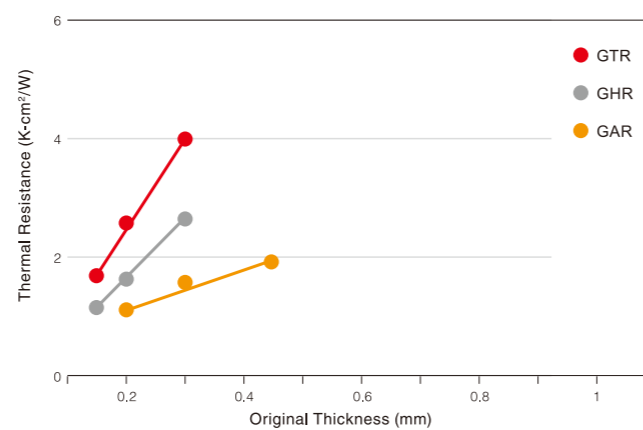

Measured by using FUJIPOLY Original, refer to FUJIPOLY Test method 'FTM P-3070'. → See P.45
Original Thickness is the initial thickness of SARCON before pressing.

Reliability of SARCON materials

TR(30TR)

Test Properties	unit	initial	150°C	200°C	60°C(underwater)
			After 1,000hrs	After 1,000hrs	After 500hrs
Hardness	IRHD	75	83	90	73
Tensile Strength	Mpa	4.8	5.0	5.9	-
Elongation	%	100	50	30	-
Volume Resistivity	Ohm-m	2.9x10 ¹²	5.6x10 ¹³	7.2x10 ¹³	6.1x10 ¹¹
Breakdown Voltage	kV	10	8	8	6

HR (30HR)

Test Properties	unit	initial	150°C	200°C	60°C(underwater)
			After 1,000hrs	After 1,000hrs	After 500hrs
Hardness	IRHD	93	94	98	86
Tensile Strength	Mpa	5.6	3.9	5.6	-
Elongation	%	60	25	25	-
Volume Resistivity	Ohm-m	9.0x10 ¹³	1.0x10 ¹³	9.4x10 ¹³	2.4x10 ¹¹
Breakdown Voltage	kV	9	7	7	4

YR-a (30Y-a)

Test Properties	unit	initial	150°C	200°C	60°C / 95%RH
			After 1,000hrs	After 1,000hrs	After 500hrs
Hardness	IRHD	86	94	99	89
Tensile Strength	Mpa	4.5	5.3	5.6	4.5
Elongation	%	73	40	20	75
Volume Resistivity	Ohm-m	1.0x10 ¹³	1.0x10 ¹³	3.0x10 ¹³	3.0x10 ¹²
Breakdown Voltage	kV	10	10	10	10

YR-d (20Y-d)

Test Properties	unit	initial	150°C	200°C	60°C / 95%RH
			After 1,000hrs	After 1,000hrs	After 1,000hrs
Hardness	IRHD	70	85	94	66
Tensile Strength	Mpa	2.4	3.1	3.9	2.1
Elongation	%	73	46	20	68
Volume Resistivity	Ohm-m	3.0x10 ¹¹	1.0x10 ¹¹	3.0x10 ¹²	4.0x10 ¹⁰
Breakdown Voltage	kV	6	7	7	7

Test Properties	Test Method	Reduced Temperature
Hardness	IRHD : ISO 7619	-40°C = -40°F
Tensile Strength	ASTM D412 / 1458	60°C = 140°F
Elongation	ASTM D412 / 1458	70°C = 158°F
Volume Resistivity	ASTM D257	80°C = 176°F
Breakdown Voltage	ASTM D149	85°C = 185°F
Dielectric Strength	ASTM D149	125°C = 257°F
		150°C = 302°F
		200°C = 390°F

GTR (15GTR)

Test Properties	unit	initial	150°C	200°C	60°C(underwater)
			After 1,000hrs	After 1,000hrs	After 500hrs
Hardness	IRHD	87	87	88	87
Tensile Strength	Mpa	71.9	59.5	43.1	-
Elongation	%	2 or less	2 or less	2 or less	-
Volume Resistivity	Ohm-m	5.7x10 ¹³	9.1x10 ¹³	1.1x10 ¹³	9.1x10 ¹¹
Breakdown Voltage	kV	4	4	3	3

GHR (15GHR)

Test Properties	unit	initial	150°C	200°C	60°C(underwater)
			After 1,000hrs	After 1,000hrs	After 500hrs
Hardness	IRHD	92	92	94	92
Tensile Strength	Mpa	52.3	51.0	38.5	-
Elongation	%	2 or less	2 or less	2 or less	-
Volume Resistivity	Ohm-m	1.1x10 ¹³	1.8x10 ¹⁴	1.8x10 ¹⁴	3.2x10 ¹⁰
Breakdown Voltage	kV	3	3	3	3

GAR (20GAR)

Test Properties	unit	initial	150°C	60°C / 95%RH
			After 1,000hrs	After 1,000hrs
Hardness	IRHD	80	96	81
Tensile Strength	Mpa	9.7	10.3	6.3
Elongation	%	3 or less	3 or less	3 or less
Volume Resistivity	Ohm-m	1.0x10 ¹¹	4.9x10 ¹²	0.2x10 ¹¹
Breakdown Voltage	kV	10	11	11
Dielectric Strength	kV	9	9	9

Thickness of SARCON materials / Standard Type

SARCON	Construction	Thickness (mm)
TR	30T	0.3 + 0.1/-0
	45T	0.45 ± 0.05
	85T	0.85 ± 0.05
HR	30H	0.3 + 0.1/-0
	45H	0.45 ± 0.05
	85H	0.85 ± 0.05
YR-a	20Y-a	0.2 ± 0.05
	30Y-a	0.3 + 0.1/-0
	45Y-a	0.45 ± 0.05
	85Y-a	0.85 ± 0.05
YR-d	20Y-d	0.2 ± 0.05
	30Y-d	0.3 + 0.1/-0
	45Y-d	0.45 ± 0.05
GTR	15GTR	0.15 + 0.02/-0.04
	20GTR	0.2 + 0.02/-0.04
	30GTR	0.3 + 0.1/-0
GHR	15GHR	0.15 + 0.02/-0.04
	20GHR	0.2 + 0.02/-0.04
	30GHR	0.3 + 0.1/-0
GAR	20GAR	0.2 ± 0.05
	30GAR	0.3 + 0.1/-0
	45GAR	0.45 ± 0.05

Case TR / HR

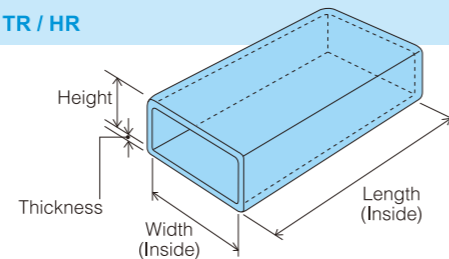

Part Number	Usable Transistors	Thickness (mm)	Dimensions (mm)	Ordering unit
30(series)-TO-220-02225	TO-220 type	0.30 +0.1/-0		500 integral multiples
45(series)-TO-220-01220		0.45 +0.1/-0.05		
90(series)-TO-220-01220		0.90 +0.15/-0.1		
30(series)-TO-3P-03281	TO-3P type	0.30 +0.1/-0		500 integral multiples
50(series)-TO-3P-02275		0.50 +0.05/-0.1		
90(series)-TO-3P-01280		0.90 +0.15/-0.1		
90(series)-TO-3P-01340		0.90 +0.1/-0.1		

Die-cut Gaskets TR / HR / YR-a / YR-d GTR / GHR / GAR

Part Number	Thickness (mm)	Dimensions (mm)	Ordering unit
30(series)-TO-220	0.30 +0.1/-0		500 integral multiples
45(series)-TO-220	0.45 ± 0.05		
30(series)-TO-3PF	0.30 +0.1/-0		
45(series)-TO-3PF	0.45 ± 0.05		

*Please contact FUJIPOLY about width tolerance.
Note: Custom size and materials available.

Tube TR / HR / YR-a

Part Number	Usable Transistors	Thickness (mm)	Inner Diameter (mm)	Length (mm)	Ordering unit
30(series)-11-25L 30(series)-11-30L	TO-220 type	0.30 +0.1/-0	φ 11±1	25±1, 30±1	500 integral multiples
45(series)-11-25L 45(series)-11-30L		0.45 ± 0.05	φ 11±1	25±1, 30±1	
85(series)-11-25L 85(series)-11-30L		0.85 ± 0.05	φ 11±1	25±1, 30±1	
30(series)-13.5-25L 30(series)-13.5-30L	TO-3P type	0.30 +0.1/-0	φ 13.5±1	25±1, 30±1	500 integral multiples
45(series)-13.5-25L 45(series)-13.5-30L		0.45 ± 0.05	φ 13.5±1	25±1, 30±1	
85(series)-13.5-25L 85(series)-13.5-30L		0.85 ± 0.05	φ 13.5±1	25±1, 30±1	

Tape TR / HR / YR-a / YR-d GTR / GHR / GAR

Part Number	Thickness (mm)	Width (mm)	Ordering unit
30(series)-36W	0.30 +0.1/-0	36	100m integral multiples
30(series)-85W		85	
45(series)-36W	0.45 ± 0.05	36	50m integral multiples
45(series)-85W		85	
85(series)-36W	0.85 ± 0.05	36	50m integral multiples
85(series)-85W		85	

*Please contact FUJIPOLY about width tolerance.

FAQ

Frequently Asked Questions

1 What is the maximum thermal conductivity of Rubber types?

It is 3.4W/m-K of SARCON YR-d (Hot Disk method).

2 What is the difference in characteristics between products with and without glass cloth reinforcement?

Products reinforced with glass cloth (GTR, GHR, etc.) are characterized by high mechanical strength. The product form is a sheet. On the other hand, products that are not reinforced with glass cloth (TR, HR, etc.) can be tape-shaped, press-molded, and extruded into irregular shapes, and are characterized by high workability.

3 What percentage of compression is needed for Rubber type materials?

Rubber type materials are not meant to be compressed by percentage. Best practice is by applying pressure via screws or springs.

4 How do Rubber types perform under low pressure?

If you want to reduce the thermal resistance, it is recommended to apply a higher pressure.

5 Thermal resistance depends on pressure, but is thermal transferred even if the pressure is low?

Although heat is transferred even when the pressure is low, it is more effective to increase the pressure to reduce the thermal resistance.

For details, see the Pressure versus Thermal resistance data on P13.

6 Do these contain low molecular weight siloxane?

Since it is a silicone rubber, it is contained, but the components that easily volatilize are removed.



GAP FILLER TYPE (GEL SHEET TYPE)

Highly Conformable and High Heat Conducting Gel Materials

SARCON Thermal Gap Filler Pads are highly conformable and high heat conducting gel materials in a versatile sheet form. They easily fit and adhere to most all shapes and sizes of components, including protrusions and recessed areas.

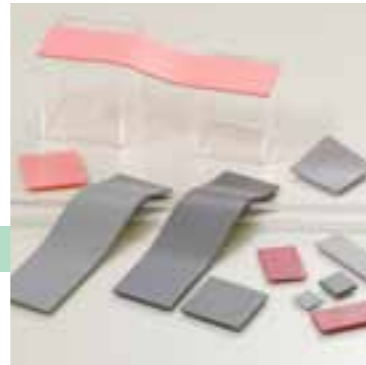

Features

GAP FILLER TYPE

- Gap filler materials are supplied in a fully cured state and remain pliable, easily conforming to minute surface irregularities.
- The basic Gap Filler Pad series can be further enhanced for special handling and die-cutting requirements.
- UL94 V-0. (with exceptions → see P.19-20)

NON-SILICONE GAP FILLER TYPE

- Contains no silicone. • Lower thermal resistance. • Available in sheets for scoring or die-cutting.

Recommended Application

You can choose suitable Gap Filler Pad thickness each gap

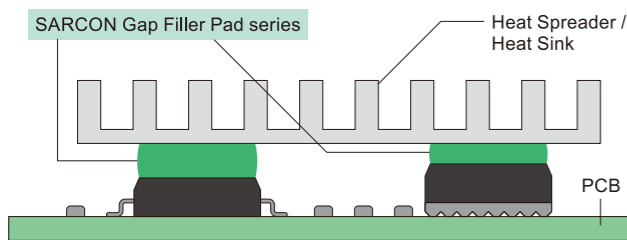

In areas where space between surface is uneven or varies and where surface textures are a concern regarding efficient thermal transfer, the supple consistency of Gap Filler Pad is excellent for filling air gaps and uneven surfaces.

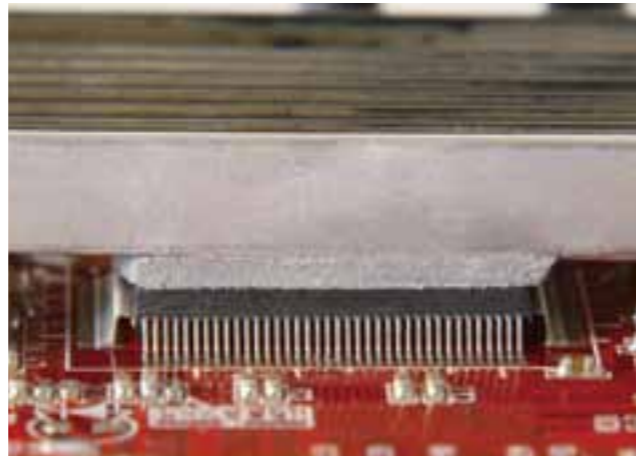

Compression Load Correlation of FUJIPOLY TIM Pad Products

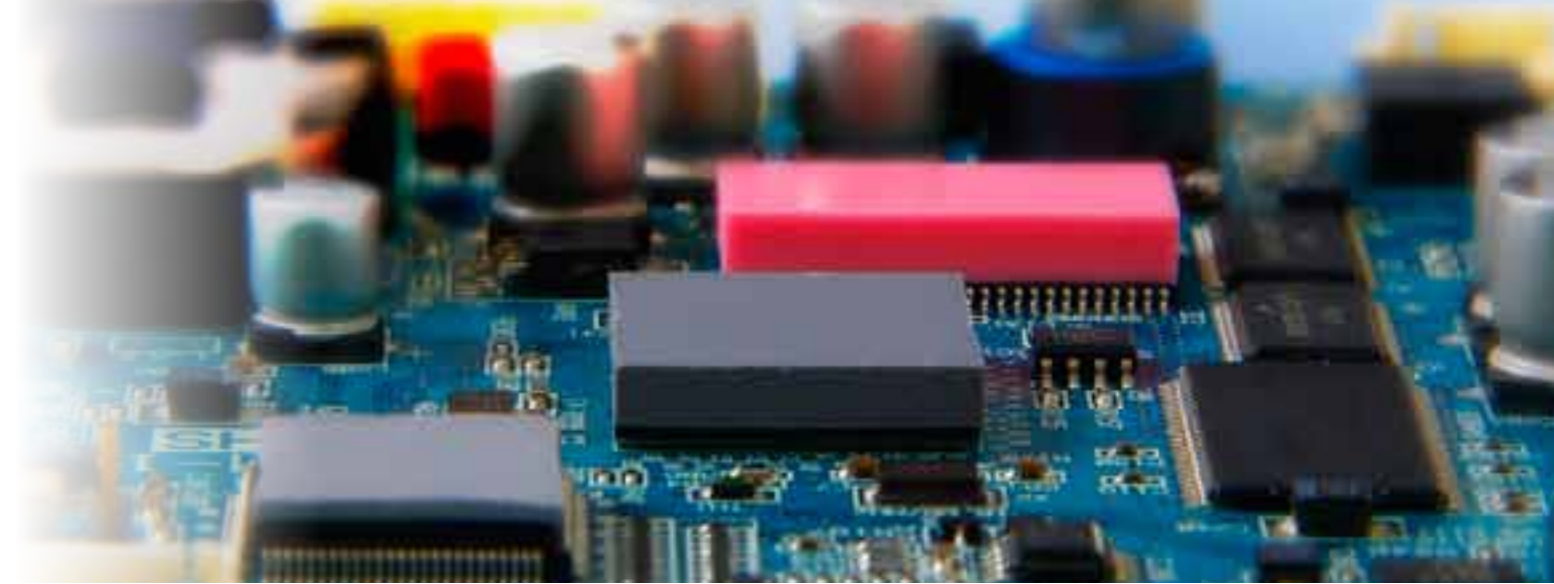
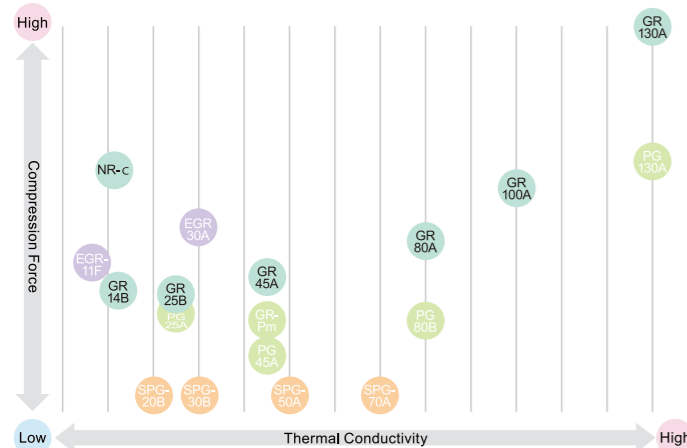

Configuring a Part Number of Gap Filler Type

Type -1 **GR 14 B - 00 - 100 PK** -Width(mm) × Length(mm)

Series	Thermal Conductivity	Serial Number	Construction	Thickness	Color	
GR	14 = 1.4W/m-K	14 B	00 = Plain Type	30 = 0.3mm	400 = 4.0mm	GY = Gray
	25 = 2.5W/m-K		0H = Hardened one Surface	50 = 0.5mm	450 = 4.5mm	RD = Red
	45 = 4.5W/m-K		0H2 = Hardened both Surface	100 = 1.0mm	500 = 5.0mm	PK = Pink
	80 = 8.0W/m-K		F0 = with Nylon Mesh	150 = 1.5mm		following
	100 = 10.0W/m-K		FH = Hardened one Surface with Nylon Mesh	200 = 2.0mm		UL-Color Codes
	130 = 13.0W/m-K (by using Hot Disk method)		E0 = PET film on one surface	250 = 2.5mm		
			T0 = with Polyester Mesh	300 = 3.0mm		
			TH = Hardened one Surface with Polyester Mesh	350 = 3.5mm		

Type -2 **100 N - HT c** -Width(mm) × Length(mm)

Thickness	Series	Construction	Variety
50 = 0.5mm	N = NR	blank = Plain Type	c = NR-c
100 = 1.0mm		H = Hardened one Surface	
150 = 1.5mm		T = with Polyester Mesh	
200 = 2.0mm		HT = Hardened one Surface with Polyester Mesh	

Variety

construction	characteristics	construction	characteristics
Plain Type	General purpose silicone compound	Hardened Surface	Same general purpose silicone compound with hardening of the top surface to facilitate handling and installation during complex assemblies.
with Mesh(Nylon or Polyester)	Same general purpose silicone compound with mesh reinforcement stiffener to prevent stretching.	Hardened Surface with Mesh(Nylon or Polyester)	Same general purpose silicone compound with hardening of the top surface to facilitate handling and installation during complex assemblies, and mesh reinforcement stiffener to prevent stretching.
PET film on one surface	Same general purpose silicone compound with PET film on one surface to facilitate Electric Isolation and to keep from scratching after repeated sliding actions.		

Highly Conformable and High Heat Conducting Gel Materials and Non-Silicone materials

Construction

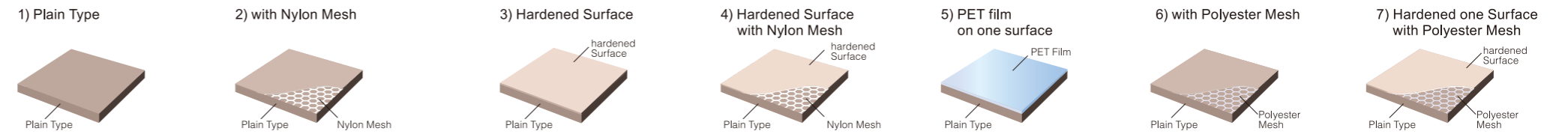

Typical Product Properties

Test Properties	Unit	Standard Gap Filler Pads				High Performance Gap Filler Pads				Non-Silicone materials	Test Method	
		GR14B	GR25B	GR45A		GR80A	GR100A	GR130A	NR-c			
Physical Properties	Construction	(above)	1) 2) 3) 4) 5)	1) 2) 6) 7)	1) 3) 5)		1) 3) 5)	1) 3)	1)	1) 3) 6) 7)	-	
	Thickness*	mm	0.5 to 5.0	0.3 to 5.0	0.5, 1.0	1.5 to 5.0	0.3 to 3.0	0.3 to 2.0	0.3 to 2.0	0.5 to 3.0	ASTM D374	
	Specific Gravity	-	1.8	2.5	3.2		3.3	3.2	3.0	2.1	ASTM D792	
	Hardness	Shore OO	30	35	60	43	75	50	74	53	ASTM D2240	
	Color	-	Pink	Pink	Gray		Light Gray	Pink	Light Gray	Light Gray	Visual	
Electrical Properties	Volume Resistivity	Ohm-m	2.4x10 ¹¹	6x10 ⁹	1x10 ¹¹		1x10 ¹¹	3x10 ¹¹	1x10 ¹⁰	1x10 ⁹	ASTM D257	
	Breakdown Voltage	kV/mm	17	12	17		15	10	14	11	ASTM D149	
	Dielectric Strength	kV/mm	10	12	14		8	9	7	-	ASTM D149	
	Dielectric Constant	-	50Hz	5.0	7.27	8.98		9.54	11.4	9.44	9.12 (50Hz)	ASTM D150
			1kHz	4.4	6.05	8.63		8.82	9.6	8.47	8.55 (110Hz)	
			1MHz	4.2	5.76	8.05		7.92	8.4	7.97	5.83 (300kHz)	
	Dissipation Factor	-	50Hz	0.095	0.559	0.025		0.063	0.372	0.157	0.152 (50Hz)	ASTM D150
1kHz			0.042	0.073	0.022		0.044	0.070	0.045	0.135 (110Hz)		
1MHz			0.004	0.014	0.007		0.014	0.024	0.010	0.034 (300kHz)		
Thermal Properties	Thermal Conductivity	W/m-K	1.4	2.5	4.5		8.0	10.0	13.0	1.3	Hot Disk : ISO 22007-2	
	Recommended Operating Temp.	°C	-40 to +150	-40 to +150	-40 to +150		-40 to +150	-40 to +150	-40 to +150	-40 to +105	-	
		°F	-40 to +302	-40 to +302	-40 to +302		-40 to +302	-40 to +302	-40 to +302	-40 to +221	-	
	Flame Retardant	-	V-0	V-0 equivalent	V-0		V-0	V-0	V-0	V-0	UL94	

a) Hardness : The highest value by using Shore OO.
 b) Thermal Conductivity : Measured by using Hot Disk method, refer to FUJIPOLY Test method "FTM P-1612". → See P.43
 * Some details of thickness. → See P.26

Thermal Resistance

unit : K-cm²/W (K-in²/W)

Pressure	GR14B				GR25B				GR45A				GR80A				GR100A				GR130A				NR-c				
	00-50PK	00-100PK	00-200PK	00-400PK	00-50PK	00-100PK	00-200PK	00-400PK	00-50GY	00-100GY	00-200GY	00-400GY	0H-30GY	0H-50GY	00-100GY	00-200GY	0H-30PK	0H-50PK	00-100PK	00-150PK	00-200PK	00-30GY	00-50GY	00-100GY	00-200GY	50N-Tc	100N-c	200N-c	300N-c
100kPa /14.5psi	3.9 (0.60)	5.8 (0.90)	10.0 (1.55)	17.1 (2.65)	1.8 (0.28)	2.9 (0.45)	5.7 (0.88)	9.3 (1.44)	1.48 (0.23)	2.25 (0.35)	3.50 (0.54)	5.95 (0.92)	0.6 (0.09)	0.8 (0.12)	1.1 (0.17)	2.3 (0.36)	0.61 (0.09)	0.68 (0.11)	0.84 (0.13)	1.06 (0.16)	1.56 (0.24)	0.25 (0.04)	0.37 (0.06)	0.70 (0.11)	1.26 (0.20)	4.0 (0.62)	6.6 (1.02)	11.3 (1.75)	16.2 (2.52)
300kPa /43.5psi	3.2 (0.50)	4.8 (0.74)	7.8 (1.21)	12.3 (1.91)	1.3 (0.20)	2.2 (0.34)	3.8 (0.59)	5.9 (0.91)	1.28 (0.20)	1.92 (0.30)	3.00 (0.47)	4.78 (0.74)	0.5 (0.08)	0.7 (0.11)	1.0 (0.16)	2.0 (0.31)	0.42 (0.07)	0.56 (0.09)	0.54 (0.08)	0.67 (0.10)	1.06 (0.16)	0.22 (0.03)	0.32 (0.05)	0.60 (0.09)	0.99 (0.15)	3.8 (0.59)	5.1 (0.78)	8.5 (1.32)	12.5 (1.93)
500kPa /72.5psi	2.8 (0.43)	4.2 (0.65)	6.7 (1.04)	10.3 (1.60)	1.2 (0.19)	1.8 (0.28)	2.9 (0.45)	4.9 (0.76)	1.15 (0.18)	1.76 (0.27)	2.62 (0.41)	3.73 (0.58)	0.4 (0.06)	0.7 (0.11)	0.9 (0.14)	1.6 (0.25)	0.35 (0.05)	0.50 (0.08)	0.35 (0.05)	0.46 (0.07)	0.69 (0.11)	0.20 (0.03)	0.30 (0.05)	0.53 (0.08)	0.70 (0.11)	3.7 (0.57)	4.0 (0.61)	7.0 (1.08)	10.2 (1.58)

c) Measured by using ASTM D5470 equivalent (TIM tester 1300), refer to FUJIPOLY Test method "FTM P-3050". → See P.44

Highly Conformable and High Heat Conducting Gel Materials and Non-Silicone materials

Initial Compression Force

GR14B

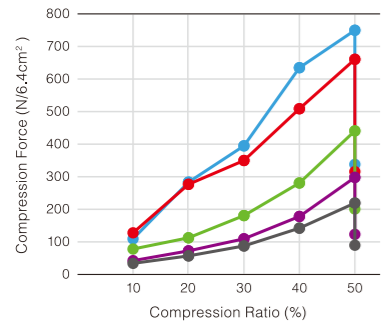

GR25B

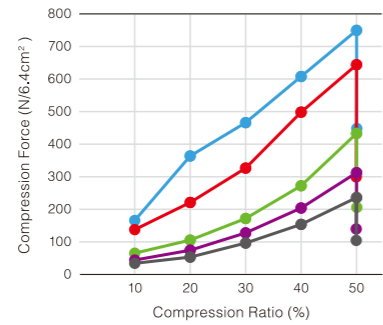

GR45A

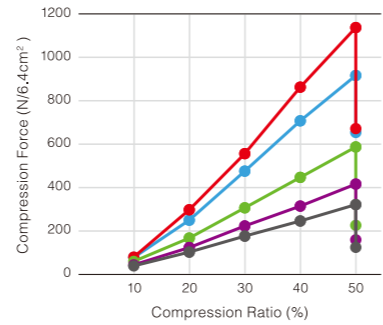

GR80A

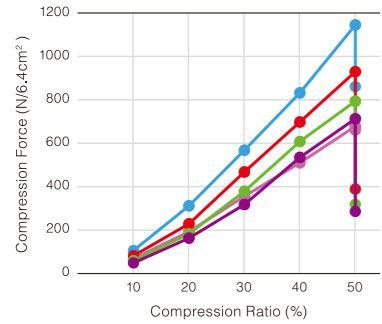

GR100A

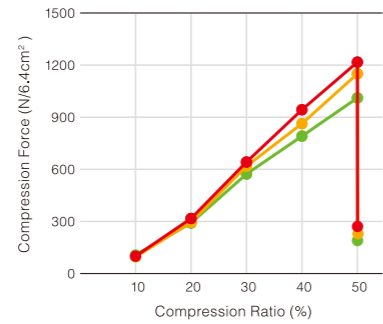

GR130A

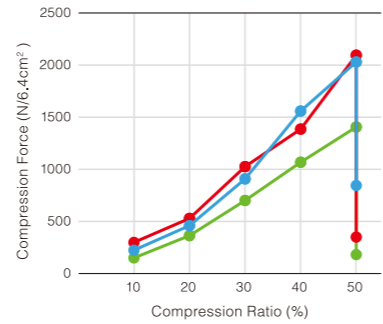

NR-c

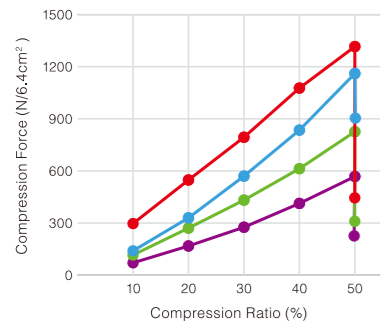

- 0.3mmT
- 0.5mmT
- 1.0mmT
- 1.5mmT
- 2.0mmT
- 3.0mmT
- 4.0mmT

50%: Relief of the forth in 1 minute later.
Measured by *ASTM D575-91* for reference. → See P.46

Compression Force

unit : N/6.4cm² (psi)

Initial → Relaxing in 1minute later

C/R	GR14B				GR25B			
	00-50PK	00-100PK	00-200PK	00-400PK	00-50PK	00-100PK	00-200PK	00-400PK
10%	109 → 24 (24.7 → 5.4)	130 → 22 (29.5 → 5.0)	79 → 10 (17.9 → 2.3)	32 → 6 (7.3 → 1.4)	165 → 81 (37.4 → 18.4)	137 → 24 (31.0 → 5.4)	65 → 16 (14.7 → 3.6)	34 → 11 (7.7 → 2.5)
20%	284 → 66 (64.3 → 15.0)	277 → 50 (62.8 → 11.3)	117 → 22 (26.5 → 5.0)	54 → 13 (12.2 → 2.9)	362 → 113 (82.0 → 25.6)	220 → 57 (49.8 → 12.9)	105 → 31 (23.8 → 7.0)	53 → 20 (12.0 → 4.5)
30%	392 → 102 (88.8 → 23.1)	351 → 101 (79.5 → 22.9)	180 → 55 (40.8 → 12.5)	87 → 29 (19.7 → 6.6)	464 → 198 (105.1 → 44.9)	325 → 116 (73.6 → 26.3)	171 → 61 (38.7 → 13.8)	96 → 37 (21.8 → 8.4)
40%	634 → 222 (143.6 → 50.3)	509 → 215 (115.3 → 48.7)	281 → 113 (63.7 → 25.6)	142 → 59 (32.2 → 13.4)	605 → 324 (137.1 → 73.4)	496 → 214 (112.4 → 48.5)	271 → 111 (61.4 → 25.1)	153 → 62 (34.7 → 14.0)
50%	752 → 335 (170.4 → 75.9)	660 → 317 (149.5 → 71.8)	442 → 202 (100.1 → 45.8)	216 → 91 (48.9 → 20.6)	746 → 446 (169.0 → 101.0)	641 → 298 (145.2 → 67.5)	431 → 205 (97.6 → 46.4)	235 → 104 (53.2 → 23.6)

C/R	GR45A				GR80A			
	00-50GY	00-100GY	00-200GY	00-400GY	0H-30GY	0H-50GY	00-100GY	00-200GY
10%	70 → 22 (15.9 → 5.0)	72 → 37 (16.3 → 8.4)	52 → 17 (11.8 → 3.9)	31 → 10 (7.0 → 2.3)	68 → 50 (15.4 → 11.3)	106 → 78 (24.0 → 17.7)	82 → 28 (18.6 → 6.3)	60 → 22 (13.6 → 5.0)
20%	243 → 154 (55.1 → 34.9)	291 → 164 (65.9 → 37.2)	160 → 64 (36.3 → 14.5)	95 → 34 (21.5 → 7.7)	193 → 182 (43.7 → 41.2)	312 → 228 (70.7 → 51.7)	229 → 134 (51.9 → 30.4)	183 → 100 (41.5 → 22.7)
30%	470 → 298 (106.5 → 67.5)	551 → 328 (124.8 → 74.3)	300 → 114 (68.0 → 25.8)	169 → 58 (38.3 → 13.1)	356 → 339 (80.7 → 76.8)	568 → 445 (128.7 → 100.8)	468 → 267 (106.0 → 60.5)	379 → 229 (85.9 → 51.9)
40%	703 → 445 (159.3 → 100.8)	859 → 512 (194.6 → 116.0)	441 → 163 (99.9 → 36.9)	239 → 82 (54.1 → 18.6)	510 → 497 (115.5 → 112.6)	832 → 621 (188.5 → 140.7)	698 → 414 (158.1 → 93.8)	608 → 347 (137.8 → 78.6)
50%	913 → 649 (206.9 → 147.0)	1135 → 667 (257.1 → 151.1)	582 → 219 (131.9 → 49.6)	315 → 117 (71.4 → 26.5)	678 → 660 (153.6 → 149.5)	1145 → 861 (259.4 → 195.1)	930 → 389 (210.7 → 88.1)	794 → 319 (179.9 → 72.3)

C/R	GR100A			GR130A		
	00-100PK	00-150PK	00-200PK	00-50GY	00-100GY	00-200GY
10%	100 → 23 (22.7 → 5.2)	96 → 18 (21.8 → 4.1)	107 → 24 (24.2 → 5.4)	224 → 35 (50.8 → 7.9)	299 → 22 (67.7 → 5.0)	140 → 16 (31.7 → 3.6)
20%	317 → 78 (71.8 → 17.7)	295 → 76 (66.8 → 17.2)	291 → 79 (65.9 → 17.9)	460 → 89 (104.2 → 20.2)	529 → 58 (119.9 → 13.1)	364 → 54 (82.5 → 12.2)
30%	642 → 121 (145.5 → 27.4)	618 → 138 (140.0 → 31.3)	573 → 148 (129.8 → 33.5)	908 → 248 (205.7 → 56.2)	1026 → 149 (232.5 → 33.8)	701 → 105 (158.8 → 23.8)
40%	943 → 173 (213.6 → 39.2)	863 → 176 (195.5 → 39.9)	791 → 176 (179.2 → 39.9)	1559 → 564 (353.2 → 127.8)	1386 → 221 (314.0 → 50.1)	1068 → 139 (242.0 → 31.5)
50%	1217 → 271 (275.7 → 61.4)	1150 → 229 (260.5 → 51.9)	1011 → 190 (229.1 → 43.0)	2030 → 845 (459.9 → 191.4)	2095 → 350 (474.6 → 79.3)	1406 → 182 (318.5 → 41.2)

C/R	NR-c			
	50N-Tc	100N-c	200N-c	300N-c
10%	140 (31.7)	297 (67.3)	116 (26.3)	71 (16.1)
20%	330 (74.8)	548 (124.2)	271 (61.4)	168 (38.1)
30%	570 (129.1)	794 (179.9)	432 (97.9)	276 (62.5)
40%	835 (189.2)	1077 (244.0)	613 (138.9)	413 (93.6)
50%	1161 → 904 (263.0 → 204.8)	1316 → 445 (298.2 → 100.8)	826 → 310 (187.1 → 70.2)	568 → 226 (128.7 → 51.2)

a) C/R : Compression Ratio
b) Relaxing : Relief of the forth in 1 minute later.
c) Measured by *ASTM D575-91* for reference. → See P.46

Highly Conformable and High Heat Conducting Gel Materials and Non-Silicone materials

Thermal Resistance Data

Pressure : 300kPa (43.5psi)

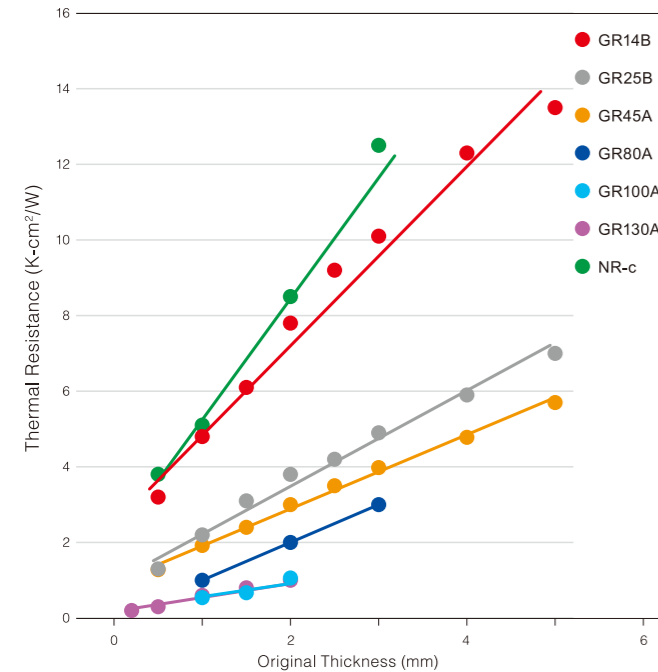

Pressure : 500kPa (72.5psi)

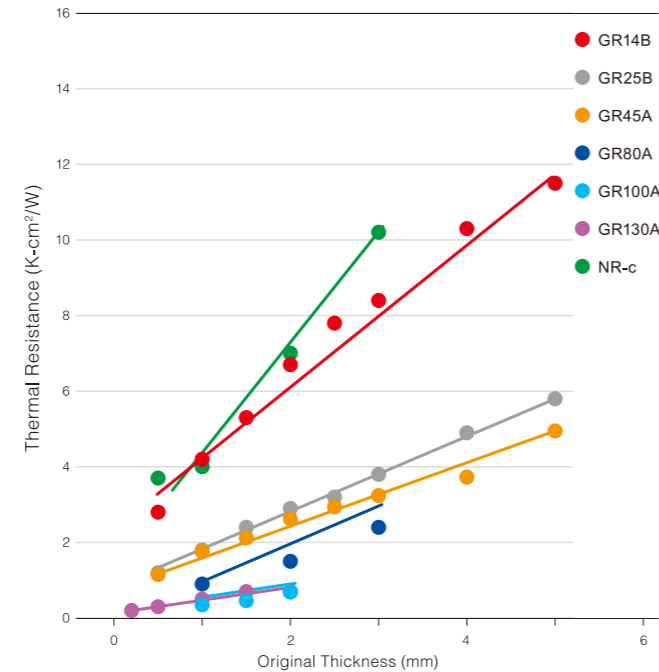

Measured by using ASTM D5470 equivalent (TIM tester 1300), refer to FUJIPOLY Test method "FTM P-3050". → See P.44
Original Thickness is the initial thickness of SARCON before pressing.

Reliability of SARCON materials

GR14B

Test Properties	unit	initial	70°C	150°C	60°C/95%RH	-40°C	-40°C(30min) ↔ +125°C(30min)
			After 1,000hrs	After 1,000hrs	After 1,000hrs	After 1,000hrs	After 1,000hrs
Specific Gravity	-	1.8	±0	±0	±0	±0	±0
Hardness	Shore 00	32	-1	+1	+2	-2	±0
Breakdown Voltage	kV/mm	16	±0	-1	+3	+2	+1
Thermal Conductivity	W/m-K	1.5	±0	±0	±0	±0	±0

*Amount of change from the initial value

GR25B

Test Properties	unit	initial	70°C	150°C	60°C/95%RH	-40°C	-40°C(30min) ↔ +125°C(30min)
			After 1,000hrs	After 1,000hrs	After 1,000hrs	After 1,000hrs	After 1,000hrs
Specific Gravity	-	2.5	2.5	2.5	2.5	2.5	2.5
Hardness	Shore 00	35	41	35	38	35	40
Breakdown Voltage	kV/mm	12	15	12	16	16	16
Thermal Conductivity	W/m-K	2.5	2.7	2.5	2.6	2.5	2.5

GR45A

Test Properties	unit	initial	70°C	150°C	60°C/95%RH	-40°C	-40°C(30min) ↔ +125°C(30min)	
			After 1,000hrs	After 1,000hrs	After 1,000hrs	After 1,000hrs	After 1,000hrs	
Specific Gravity	-	3.2	3.2	3.2	3.2	3.2	3.2	
Hardness	Shore 00	less than 1.5mm	60	64	85	61	60	69
		or more	45	44	85	50	45	54
Breakdown Voltage	kV/mm	17	18	20	17	16	19	
Thermal Conductivity	W/m-K	4.5	4.6	4.8	4.6	4.8	4.6	

GR80A

Test Properties	unit	initial	70°C	150°C	60°C/95%RH	-40°C	-40°C(30min) ↔ +125°C(30min)
			After 1,000hrs	After 1,000hrs	After 1,000hrs	After 1,000hrs	After 1,000hrs
Specific Gravity	-	3.3	3.3	3.3	3.3	3.3	3.3
Hardness	Shore 00	75	72	92	80	70	70
Volume Resistivity	Ohm-m	2.4x10 ¹¹	2.8x10 ¹¹	1.8x10 ¹³	3.7x10 ¹¹	2.6x10 ¹¹	1.3x10 ¹²
Breakdown Voltage	kV/mm	15	14	20	17	15	17
Thermal Conductivity	W/m-K	8.0	8.0	8.0	8.0	8.0	8.0

GR100A

Test Properties	unit	initial	70°C	150°C	60°C/95%RH	-40°C	-40°C(30min) ↔ +125°C(30min)
			After 1,000hrs	After 1,000hrs	After 1,000hrs	After 1,000hrs	After 1,000hrs
Specific Gravity	-	3.2	3.2	3.2	3.2	3.2	3.2
Hardness	Shore 00	50	67	80	57	74	66
Breakdown Voltage	kV/mm	10	13	18	10	11	13
Thermal Resistance	K-cm ² /W	-*	+0.05	+0.01	+0.01	-0.02	+0.05

*Amount of change from the initial value

GR130A

Test Properties	unit	initial	70°C	150°C	60°C/95%RH	-40°C	-40°C(30min) ↔ +125°C(30min)
			After 1,000hrs	After 1,000hrs	After 1,000hrs	After 1,000hrs	After 1,000hrs
Specific Gravity	-	3.0	3	2.9	3	3	3
Hardness	Shore 00	74	80	94	89	74	91
Breakdown Voltage	kV/mm	14	16	18	18	13	17
Thermal Resistance	K-cm ² /W	-*	-0.04	+0.08	±0	+0.04	-0.02

*Amount of change from the initial value

NR-c

Test Properties	unit	initial	80°C	125°C	85°C/85%RH	-40°C	-40°C(30min) ↔ +85°C(30min)
			After 1,000hrs	After 1,000hrs	After 1,000hrs	After 1,000hrs	After 1,000hrs
Specific Gravity	-	2.1	2.1	2.2	2.1	2.1	2.1
Hardness	ASKER C	27	30	57	28	37	37
Breakdown Voltage	kV/mm	11	18	26	15	27	27
Thermal Resistance	K-cm ² /W	6.8	7.5	9.9	7.3	10.4	10.4

FAQ Frequently Asked Questions

SARCON GAP FILLER TYPE (GEL SHEET TYPE)

Gel sheet type

1 What is the maximum thermal conductivity of Gel sheet types?

It is 13.0 W/m-K of SARCON GR130A(Hot Disk method).

2 What is the difference between Gel sheet type and Putty sheet type?

Gel sheet type have some resilience and excellent workability. Putty sheet types have excellent conformability, and the ability to cover parts with varying heights.

3 How much pressure/compression is needed for the material to work adequately?

Heat is transferred when there is contact, but we recommend a compression rate of about 30%.

4 How do you select the type of material?

You should consider the thickness, thermal conductivity, hardness, and compatibility with the parts to be contacted.

Non-silicone sheet type

1 What are non-silicone materials made from and what is the difference compared to silicone products?

The material has an acrylate Resin. Regarding the difference, the recommended operating temperature for the non-silicone type is -40°C to 105°C, compared to silicone type -40°C to 150°C.

5 What are the ingredients of the filler?

Ceramic-based thermally conductive fillers such as aluminum oxide are used to ensure electrical insulation.

6 Will Gel type material exhibit any oil bleeding? What is the oil that seeps out if oil bleeding occurs and what are the effects?

Yes, all Gel sheet type will exhibit some Silicone oil bleeding. The oil that seeps out is dimethyl silicone oil. Dimethyl silicone oil is chemically stable and does not corrode the substrate.

7 Are there any Low-molecular Siloxane free products?

Since our products are configured for Low-molecular Siloxane reduction, outgassing is minimal. We also have a lineup of non-silicone materials, such as SARCON NR-c.

Test Properties	Test Method	Reduced Temperature
Hardness	Shore 00 : ASTM D2240	-40°C = -40°F
	ASKER C : JIS K7312	60°C = 140°F
Tensile Strength	ASTM D412 / 1458	70°C = 158°F
Elongation	ASTM D412 / 1458	80°C = 176°F
Volume Resistivity	ASTM D257	85°C = 185°F
Breakdown Voltage	ASTM D149	125°C = 257°F
Dielectric Strength	ASTM D149	150°C = 302°F
Specific Gravity	ASTM D792	200°C = 390°F
Thermal Conductivity	ISO 22007-2	
Thermal Resistance	ASTM D5470 modified	

Highly Conformable and High Heat Conducting Gel Materials and Non-Silicone materials

Relaxing Compression Force versus Thermal Resistance

(Relaxing Compression Force : Relief of Compression Force in one minute)

*For reference purpose only (Calculated value)

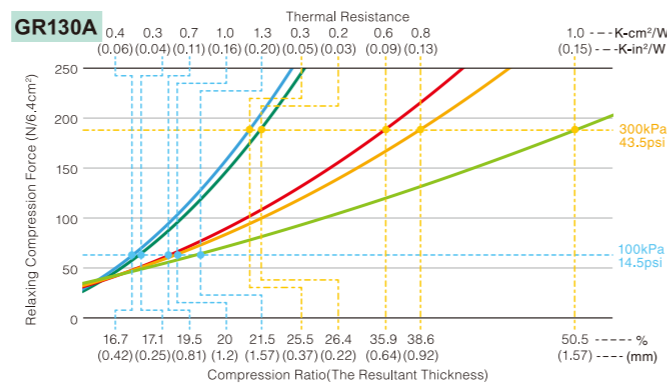
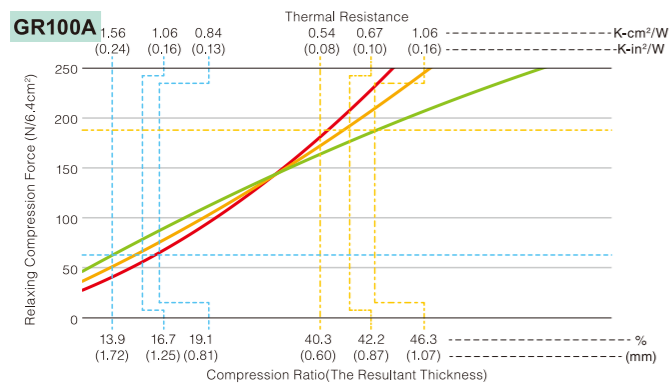
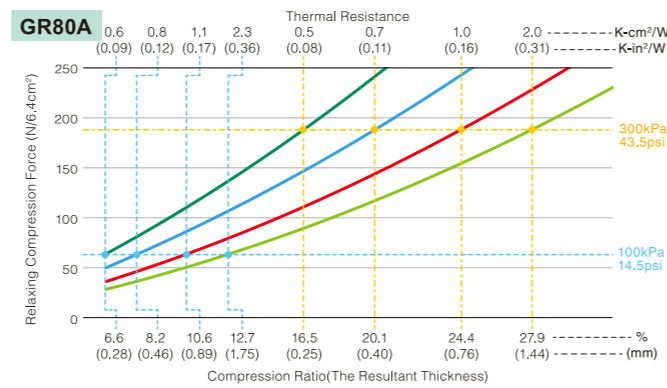
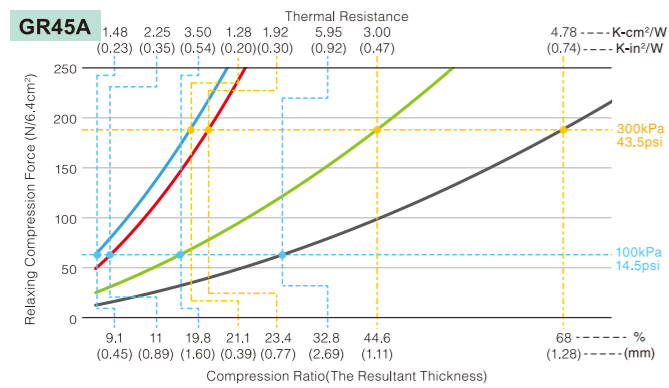
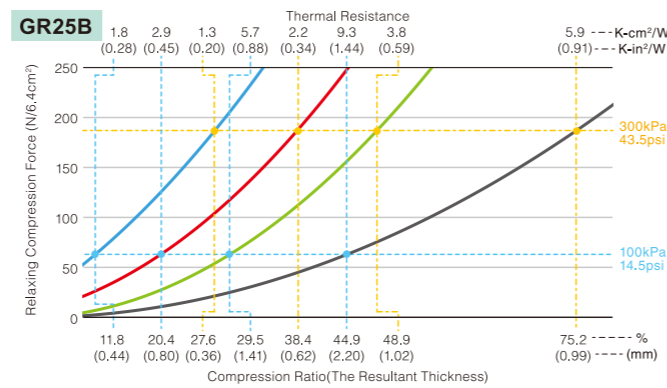
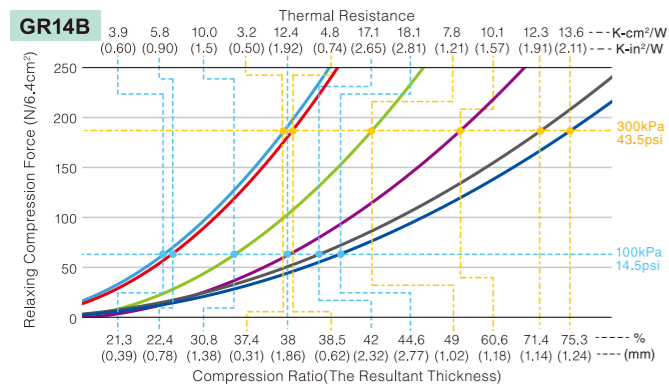
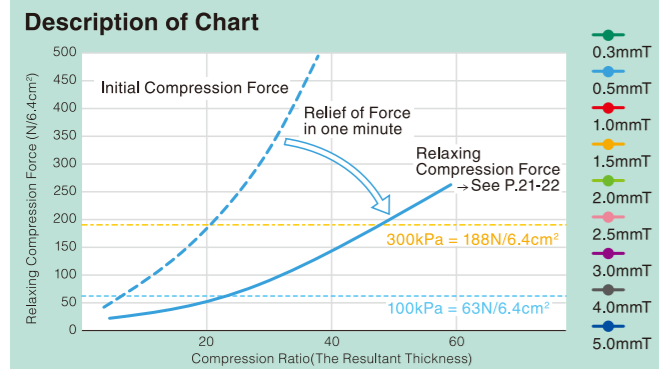

- a) Specimen size : for Compression Force : Dia. 28.6mm → See P.46
for Thermal Resistance : Dia. 33.0mm → See P.44
- b) The resultant thickness is the gap thickness after relieving of compression force in one minute.
- c) ●: Thermal Resistance at 100kPa by using TIM tester ●: Thermal Resistance at 300kPa by using TIM tester

Thickness of SARCON materials

SARCON	Construction	Thickness (mm)	Sheet (mm)	
GR14B	GR14B-00-50PK	GR14B-0H-50PK	0.5 ± 0.05	300 x 200 (Recommended Usable Size; 290 x 190)
	GR14B-F0-50PK	GR14B-FH-50PK	0.5 ± 0.15	
	GR14B-00-100PK	GR14B-0H-100PK	1.0 ± 0.10	
	GR14B-F0-100PK	GR14B-FH-100PK	1.0 ± 0.20	
	GR14B-00-150PK	GR14B-0H-150PK	1.5 ± 0.15	
	GR14B-F0-150PK	GR14B-FH-150PK	1.5 ± 0.20	
	GR14B-00-200PK	GR14B-0H-200PK	2.0 ± 0.20	
	GR14B-F0-200PK	GR14B-FH-200PK	2.0 ± 0.30	
	GR14B-00-250PK	GR14B-0H-250PK	2.5 ± 0.25	
	GR14B-00-300PK	GR14B-0H-300PK	3.0 ± 0.30	
	GR14B-00-350PK	GR14B-0H-350PK	3.5 ± 0.35	
	GR14B-00-450PK	GR14B-0H-450PK	4.5 ± 0.45	
	GR14B-00-500PK	GR14B-0H-500PK	5.0 ± 0.50	
	GR25B	-	GR25B-0H2-30PK	
GR25B-00-50PK		GR25B-0H-50PK	0.5 ± 0.05	
GR25B-T0-50PK		GR25B-TH-50PK	0.5 ± 0.15	
GR25B-00-100PK		GR25B-0H-100PK	1.0 ± 0.10	
GR25B-T0-100PK		GR25B-TH-100PK	1.0 ± 0.20	
GR25B-00-150PK		GR25B-0H-150PK	1.5 ± 0.15	
GR25B-T0-150PK		GR25B-TH-150PK	1.5 ± 0.20	
GR25B-00-200PK		GR25B-0H-200PK	2.0 ± 0.20	
GR25B-T0-200PK		GR25B-TH-200PK	2.0 ± 0.30	
GR25B-00-250PK		GR25B-0H-250PK	2.5 ± 0.25	
GR45A	GR45A-00-50GY	GR45A-0H-50GY	0.5 ± 0.15	300 x 200 (Recommended Usable Size; 280 x 190)
	GR45A-00-100GY	GR45A-0H-100GY	1.0 ± 0.20	
	GR45A-00-150GY	GR45A-0H-150GY	1.5 ± 0.20	
	GR45A-00-200GY	GR45A-0H-200GY	2.0 ± 0.30	
	GR45A-00-250GY	GR45A-0H-250GY	2.5 ± 0.30	
	GR45A-00-300GY	GR45A-0H-300GY	3.0 ± 0.30	
	GR45A-00-350GY	GR45A-0H-350GY	3.5 ± 0.35	
	GR45A-00-400GY	GR45A-0H-400GY	4.0 ± 0.40	
	GR45A-00-450GY	GR45A-0H-450GY	4.5 ± 0.45	
	GR45A-00-500GY	GR45A-0H-500GY	5.0 ± 0.50	

SARCON	Construction	Thickness (mm)	Sheet (mm)	
GR80A	-	GR80A-0H-30GY	0.3 ± 0.06	300 x 200 (Recommended Usable Size; 280 x 180)
	-	GR80A-0H-50GY	0.5 ± 0.10	
	GR80A-00-100GY	GR80A-0H-100GY	1.0 ± 0.15	
	GR80A-00-150GY	GR80A-0H-150GY	1.5 ± 0.20	
	GR80A-00-200GY	GR80A-0H-200GY	2.0 ± 0.30	
	GR80A-00-250GY	GR80A-0H-250GY	2.5 ± 0.30	
	GR80A-00-300GY	GR80A-0H-300GY	3.0 ± 0.30	
GR100A	-	GR100A-0H-30PK	0.3 ± 0.06	300x200 (Recommended Usable Size; 290 x 190)
	-	GR100A-0H-50PK	0.5 ± 0.15	
	GR100A-00-100PK	GR100A-0H-100PK	1.0 ± 0.20	
	GR100A-00-150PK	GR100A-0H-150PK	1.5 ± 0.20	
GR130A	GR130A-00-30GY	-	0.3 ± 0.06	300x200 (Recommended Usable Size; 290 x 190)
	GR130A-00-50GY	-	0.5 ± 0.10	
	GR130A-00-100GY	-	1.0 ± 0.20	
	GR130A-00-150GY	-	1.5 ± 0.20	
NR-c	50N-Tc	50N-HTc	0.5 ± 0.15	300 x 200 (Recommended Usable Size; 290 x 190)
	100N-c	100N-Hc	1.0 ± 0.10	
	100N-Tc	100N-HTc	1.0 ± 0.20	
	150N-c	150N-Hc	1.5 ± 0.15	
	150N-Tc	150N-HTc	1.5 ± 0.20	
	200N-c	200N-Hc	2.0 ± 0.20	
	200N-Tc	200N-HTc	2.0 ± 0.30	
	250N-c	250N-Hc	2.5 ± 0.25	
	300N-c	300N-Hc	3.0 ± 0.30	

Note: Please do not hesitate to contact with us if you do not see what you need.

SARCON EXTREMELY COMPRESSIBLE GAP FILLER TYPE (PUTTY SHEET TYPE)

Highly Thermally Conductive and Non-Flammable interface materials

SARCON Silicone Extremely Compressible Gap Filler Type (Putty sheet type) is a highly conductive and thermally conductive, non-flammable interface materials.

The surface consistency is excellent for filling small air gaps and uneven mating surfaces, making reliable contact with various shapes and sizes of components.

Features

- Very low compression force at high compression rate.
- Suitable for gaps as small as 0.3mm or less.
- UL94 V-0.



Recommended Application

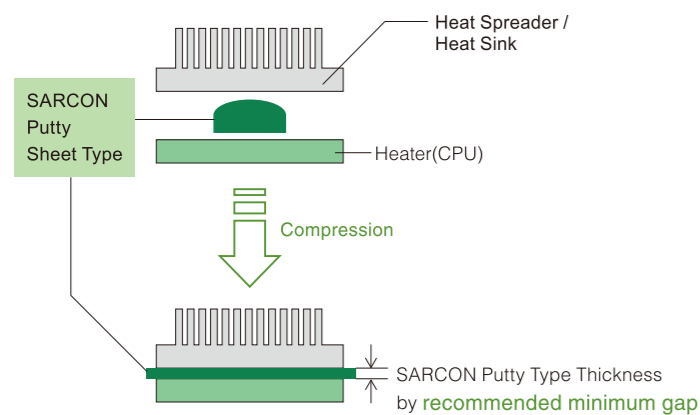

To determine the size and volume of SARCON Putty Type to be used, follow this helpful example:



EX.
 $V=45\text{mm}^3$ (0.2mmT x 15mmW x 15mmL)
 Decide Thickness of SARCON depend on the compression force
 e.g. Decided Thickness = 2mm
 $\sqrt{45(V)} \div 2$ (Thickness) = 4.74mm
 → use 5mm x 5 mm @ 2.0mm Thickness

Compression Load Correlation of FUJIPOLY TIM Pad Products

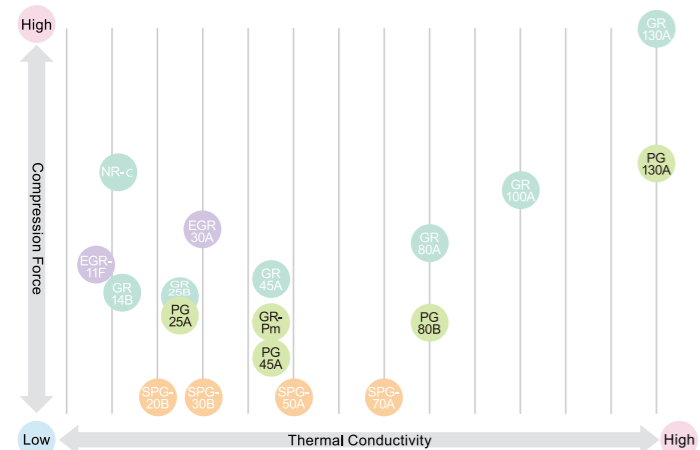

Thermal Resistance Data

Pressure : 300kPa (43.5psi)

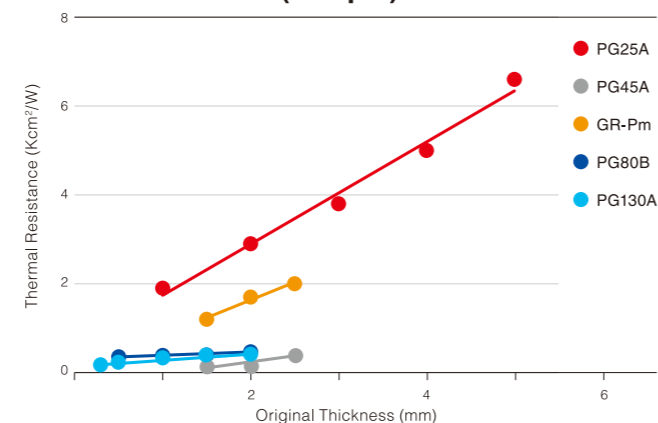

Measured by using ASTM D5470 equivalent (TIM tester 1300), refer to FUJIPOLY Test method "FTM P-3050". → See P.44
 Original Thickness is the initial thickness of SARCON before pressing.

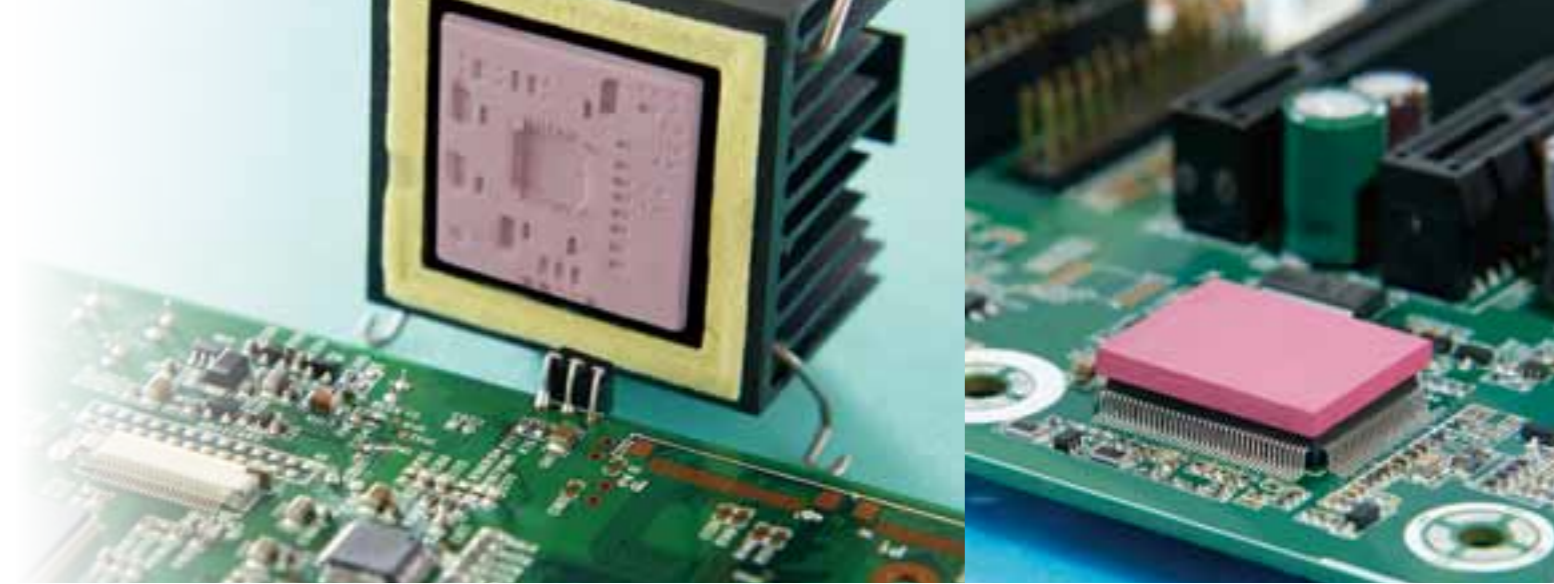

Configuring a Part Number of Gap Filler Type

Type -1

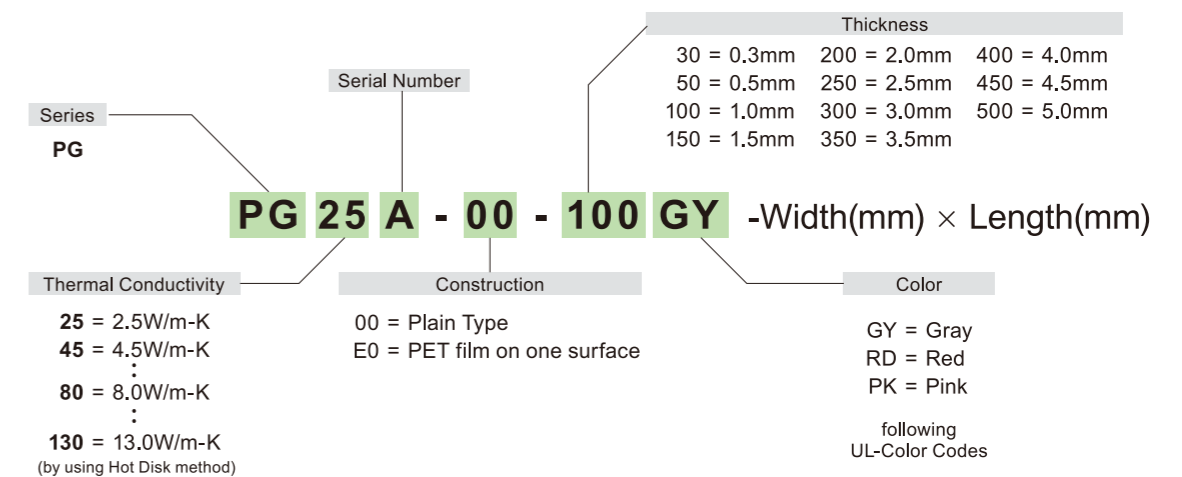

Type -2

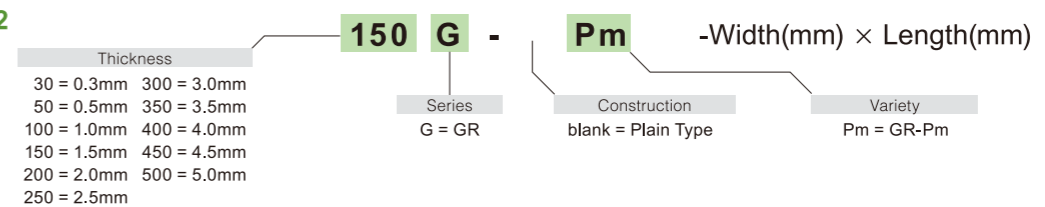

Variety

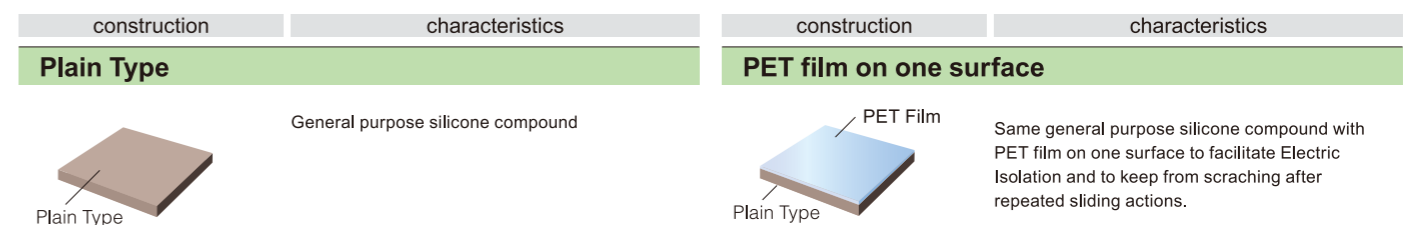

SARCON GAP FILLER TYPE (PUTTY SHEET TYPE)

Highly Thermally Conductive and Non-Flammable interface materials

Typical Product Properties

Test Properties		Unit	PG25A	PG45A	GR-Pm	PG80B	PG130A	Test Method	
Physical Properties	Construction	(above)	1) 5)	1)	1)	1)	1)	-	
	Thickness*	mm	1.0 to 5.0	1.5 to 2.5	1.5 to 2.5	0.5 to 2.0	0.3 to 2.0	ASTM D374	
	Specific Gravity	-	2.6	3.3	3.2	3.3	3.0	ASTM D792	
	Color	-	Gray	Gray	Dark Reddish Gray	Red	Pink	Visual	
Electrical Properties	Volume Resistivity	Ohm-m	1x10 ¹¹	-**	1x10 ¹²	3x10 ¹¹	2x10 ⁹	ASTM D257	
	Breakdown Voltage	kV/mm	18	-**	18	10	13	ASTM D149	
	Dielectric Strength	kV/mm	10	-**	13	4	8	ASTM D149	
	Dielectric Constant	-	50Hz	7.21	7.31	7.37	12.1	13.6	ASTM D150
			1kHz	6.73	7.30	7.31	9.6	10.6	
			1MHz	6.25	7.17	7.34	8.6	9.3	
	Dissipation Factor	-	50Hz	0.059	0.035	0.010	0.533	0.500	ASTM D150
1kHz			0.031	0.010	0.002	0.093	0.095		
1MHz			0.007	0.006	0.001	0.015	0.029		
Thermal Properties	Thermal Conductivity	W/m-K	2.5	4.5	4.5	8.0	13.0	Hot Disk : ISO 22007-2	
	Recommended Operating Temp.	°C	-40 to +150	-40 to +150	-40 to +150	-40 to +150	-40 to +150	-	
		°F	-40 to +302	-40 to +302	-40 to +302	-40 to +302	-40 to +302		
	Flame Retardant	-	V-0	V-0	V-0	V-0	V-0	UL94	

a) Thermal Conductivity : Measured by using Hot Disk method, refer to FUJIPOLY Test method "FTM P-1612". → See P.43

* Some details of thickness. → See P.34

**Cannot measure, because it is a soft product.

Construction

1) Plain Type

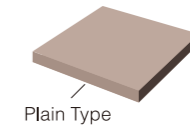

5) PET film on one surface

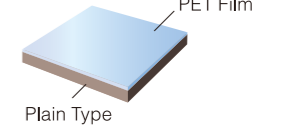

Thermal Resistance

unit : K-cm²/W (K-in²/W)

Pressure	PG25A				PG45A			GR-Pm			PG80B				PG130A				
	00-100GY	00-200GY	00-300GY	00-400GY	00-150GY	00-200GY	00-250GY	150G-Pm	200G-Pm	250G-Pm	00-50RD	00-100RD	00-150RD	00-200RD	00-30PK	00-50PK	00-100PK	00-150PK	00-200PK
100kPa /14.5psi	2.7 (0.42)	4.9 (0.76)	6.6 (1.02)	8.2 (1.27)	0.75 (0.12)	0.83 (0.13)	0.86 (0.13)	2.9 (0.45)	3.3 (0.52)	4.3 (0.67)	0.55 (0.09)	0.92 (0.14)	1.22 (0.19)	1.43 (0.22)	0.20 (0.03)	0.29 (0.04)	0.65 (0.10)	0.83 (0.13)	1.07 (0.17)
300kPa /43.5psi	1.9 (0.29)	2.9 (0.45)	3.8 (0.59)	5.0 (0.78)	0.13 (0.02)	0.14 (0.02)	0.38 (0.06)	1.2 (0.19)	1.7 (0.26)	2.0 (0.31)	0.35 (0.05)	0.37 (0.06)	0.39 (0.06)	0.46 (0.07)	0.17 (0.03)	0.23 (0.04)	0.34 (0.05)	0.39 (0.06)	0.41 (0.06)
500kPa /72.5psi	1.5 (0.23)	2.2 (0.34)	3.0 (0.47)	4.1 (0.64)	0.09 (0.01)	0.09 (0.01)	0.37 (0.06)	0.8 (0.12)	1.0 (0.16)	1.4 (0.22)	0.27 (0.04)	0.26 (0.04)	0.28 (0.04)	0.30 (0.05)	0.14 (0.02)	0.19 (0.03)	0.21 (0.03)	0.21 (0.03)	0.22 (0.03)

c) Measured by using ASTM D5470 equivalent (TIM tester 1300), refer to FUJIPOLY Test method "FTM P-3050". → See P.44

SARCON GAP FILLER TYPE (PUTTY SHEET TYPE)

Highly Thermally Conductive and Non-Flammable interface materials

Initial Compression Force

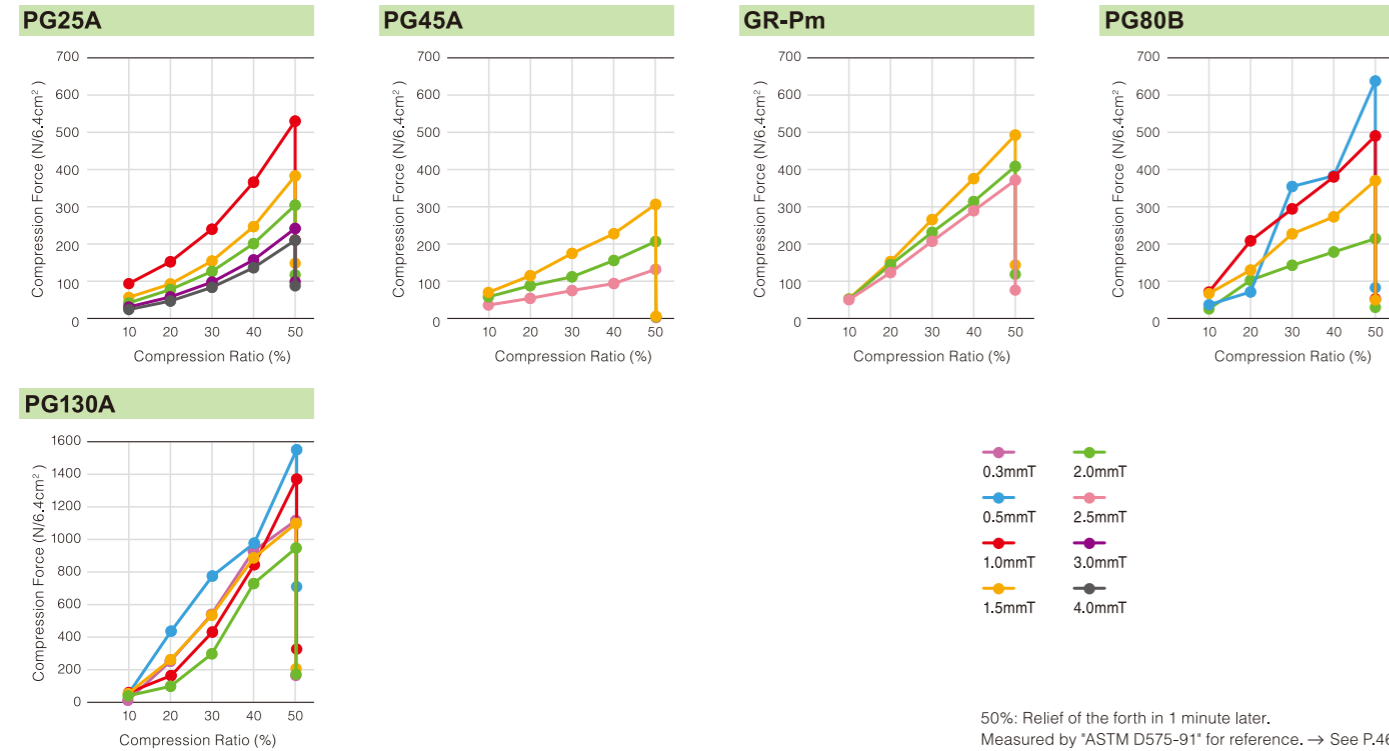

Compression Force

unit : N/6.4cm² (psi)

Initial → Relaxing in 1minute later

C/R	PG25A			PG45A			GR-Pm		
	00-100GY	00-200GY	00-400GY	00-150GY	00-200GY	00-250GY	150G-Pm	200G-Pm	250G-Pm
10%	94 → 13 (21.3 → 2.9)	42 → 7 (9.5 → 1.6)	24 → 5 (5.4 → 1.1)	70 → 1 (15.9 → 0.2)	58 → 1 (13.1 → 0.2)	36 → <1 (8.2 → <0.2)	53 → 9 (12.0 → 2.0)	52 → 7 (11.8 → 1.6)	50 → 5 (11.3 → 1.1)
20%	153 → 34 (34.7 → 7.7)	78 → 20 (17.7 → 4.5)	47 → 11 (10.7 → 2.5)	115 → 1 (26.1 → 0.2)	88 → 2 (19.9 → 0.5)	54 → 1 (12.2 → 0.2)	153 → 42 (34.7 → 9.5)	144 → 31 (32.6 → 7.0)	123 → 23 (27.9 → 5.2)
30%	241 → 65 (54.6 → 14.7)	127 → 36 (28.8 → 8.2)	84 → 23 (19.0 → 5.2)	175 → 3 (39.6 → 0.7)	112 → 2 (25.4 → 0.5)	75 → 1 (17.0 → 0.2)	265 → 72 (60.0 → 16.3)	231 → 58 (52.3 → 13.1)	207 → 39 (46.9 → 8.8)
40%	368 → 125 (83.4 → 28.3)	202 → 63 (45.8 → 14.3)	137 → 45 (31.0 → 10.2)	228 → 4 (51.7 → 0.9)	156 → 3 (35.3 → 0.7)	94 → 1 (21.3 → 0.2)	375 → 103 (85.0 → 23.3)	314 → 82 (71.1 → 18.6)	289 → 54 (65.5 → 12.2)
50%	533 → 212 (120.8 → 48.0)	306 → 118 (69.3 → 26.7)	211 → 88 (47.8 → 19.9)	307 → 6 (69.6 → 1.4)	207 → 4 (46.9 → 0.9)	132 → 2 (29.9 → 0.5)	492 → 144 (111.5 → 32.6)	408 → 118 (92.4 → 26.7)	371 → 76 (84.1 → 17.2)

C/R	PG80B			PG130A					
	00-50RD	00-100RD	00-150RD	00-200RD	00-30PK	00-50PK	00-100PK	00-150PK	00-200PK
10%	37 → 5 (8.4 → 1.1)	73 → 7 (16.5 → 1.6)	70 → 9 (15.9 → 2.0)	27 → 3 (6.1 → 0.7)	22 → 2 (5.0 → 0.5)	57 → 4 (12.9 → 0.9)	60 → 6 (13.6 → 1.4)	54 → 6 (12.2 → 1.4)	37 → 5 (8.4 → 1.1)
20%	74 → 9 (16.8 → 2.0)	210 → 24 (47.6 → 5.4)	130 → 17 (29.5 → 3.9)	104 → 17 (23.6 → 3.9)	253 → 96 (57.3 → 21.8)	440 → 106 (99.7 → 24.0)	159 → 24 (36.0 → 5.4)	258 → 47 (58.5 → 10.6)	99 → 18 (22.4 → 4.1)
30%	355 → 44 (80.4 → 10.0)	298 → 35 (67.5 → 7.9)	227 → 30 (51.4 → 6.8)	142 → 23 (32.2 → 5.2)	541 → 289 (122.6 → 65.5)	782 → 271 (177.2 → 61.4)	431 → 110 (97.6 → 24.9)	534 → 114 (121.0 → 25.8)	294 → 70 (66.6 → 15.9)
40%	386 → 45 (87.5 → 10.2)	381 → 41 (86.3 → 9.3)	274 → 34 (62.1 → 7.7)	179 → 27 (40.6 → 6.1)	931 → 602 (210.9 → 136.4)	930 → 378 (210.7 → 85.6)	846 → 206 (191.7 → 46.7)	838 → 172 (189.9 → 39.0)	730 → 148 (165.3 → 33.5)
50%	638 → 83 (144.5 → 18.8)	489 → 50 (110.8 → 11.3)	371 → 45 (84.1 → 10.2)	212 → 30 (48.0 → 6.8)	1112 → 769 (251.9 → 174.2)	1549 → 723 (350.9 → 163.8)	1364 → 333 (309.0 → 75.4)	1097 → 209 (248.5 → 47.4)	940 → 176 (213.0 → 39.9)

C/R : Compression Ratio
Relaxing : Relief of the forth in 1 minute later.
Measured by *ASTM D575-91* for reference. → See P.46

Reliability of SARCON materials

Test Properties	unit	initial	70°C	150°C	60°C/95%RH	-40°C	-40°C(30min)↔ +125°C(30min)
			After 1,000hrs	After 1,000hrs	After 1,000hrs	After 1,000hrs	After 1,000hrs
Specific Gravity	-	2.6	2.6	2.6	2.6	2.6	2.6
Hardness	ASKERC	8	16	43	8	8	47
Breakdown Voltage	kV/mm	18	17	21	16	16	19
Thermal Conductivity	W/m-K	2.5	2.5	2.5	2.5	2.5	2.5

Test Properties	unit	initial	70°C	150°C	60°C/95%RH	-40°C	-40°C(30min)↔ +125°C(30min)
			After 1,000hrs	After 1,000hrs	After 1,000hrs	After 1,000hrs	After 1,000hrs
Specific Gravity	-	3.3	3.3	3.3	3.3	3.3	3.3
Thermal Conductivity	W/m-K	4.6	4.6	4.8	4.6	4.5	4.6
Thermal Resistance	K-cm ² /W	0.9	0.9	1.0	0.9	1.0	1.0

Test Properties	unit	Compression Ratio	initial (avg.)	70°C	150°C	60°C/90%RH	-40°C(30min)↔ +125°C(30min)
				After 1,000hrs	After 1,000hrs	After 1,000hrs	After 1,000hrs
Thermal Resistance	K-cm ² /W	30%	1.7	1.8	2.3	1.7	1.8
		70%	0.9	0.9	1.3	0.9	1.1
		90%	0.5	0.4	0.4	0.6	0.4

Test Properties	unit	Compression Ratio	initial (avg.)	70°C	150°C	60°C/95%RH	85°C/85%RH	-40°C(30min)↔ +125°C(30min)
				After 1,000hrs	After 1,000hrs	After 1,000hrs	After 1,000hrs	After 1,000hrs
Thermal Resistance	K-cm ² /W	30%	0.89	±0	+0.01	-0.01	+0.01	-0.01
		70%	0.49	-0.03	-0.01	-0.02	-0.03	-0.05

*Amount of change from the initial value

Test Properties	unit	Compression Ratio	initial (avg.)	70°C	150°C	60°C/95%RH	85°C/85%RH	-40°C(30min)↔ +125°C(30min)
				After 1,000hrs	After 1,000hrs	After 1,000hrs	After 1,000hrs	After 1,000hrs
Thermal Resistance	K-cm ² /W	30%	0.54	-0.01	+0.04	-0.05	-0.01	-0.01
		70%	0.30	+0.03	-0.01	-0.03	-0.01	-0.06

*Amount of change from the initial value

Test Properties	Test Method	Reduced Temperature
Hardness	ASKER C : JIS K7312	-40°C = -40°F
Breakdown Voltage	ASTM D149	60°C = 140°F
Specific Gravity	ASTM D792	70°C = 158°F
Thermal Conductivity	ISO 22007-2	80°C = 176°F
Thermal Resistance	ASTM D5470 modified	85°C = 185°F
		125°C = 257°F
		150°C = 302°F
		200°C = 390°F

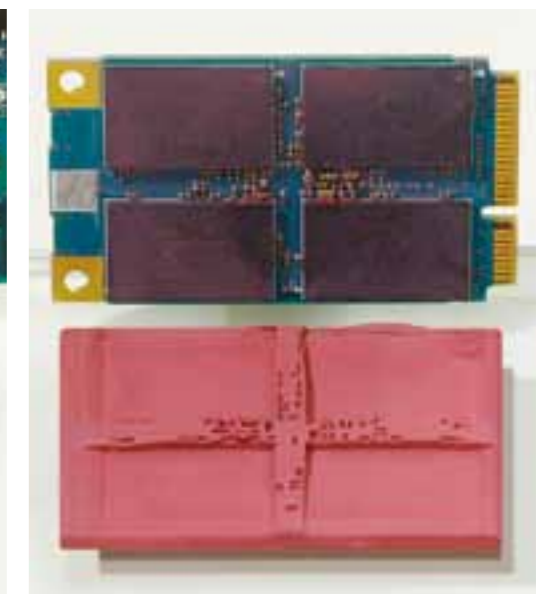

Highly Thermally Conductive and Non-Flammable interface materials

Relaxing Compression Force versus Thermal Resistance

(Relaxing Compression Force : Relief of Compression Force in one minute)

*For reference purpose only (Calculated value)

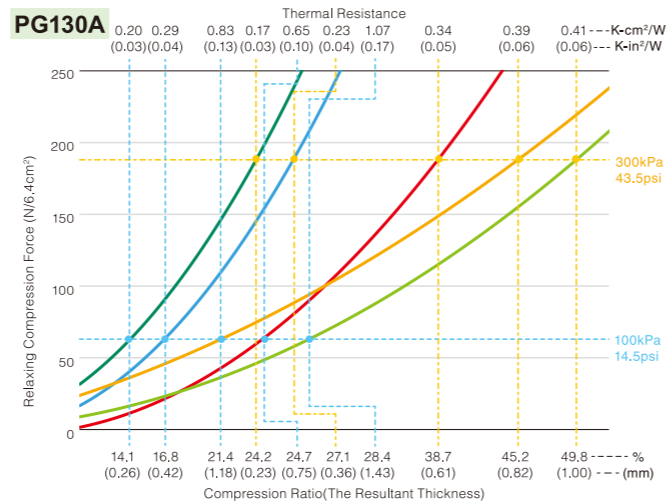
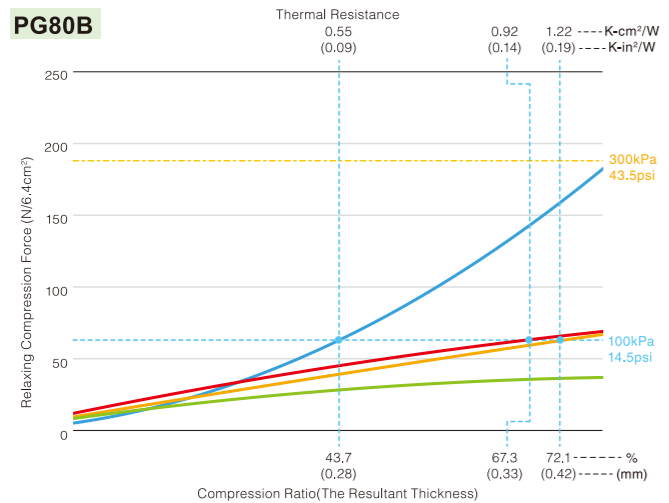
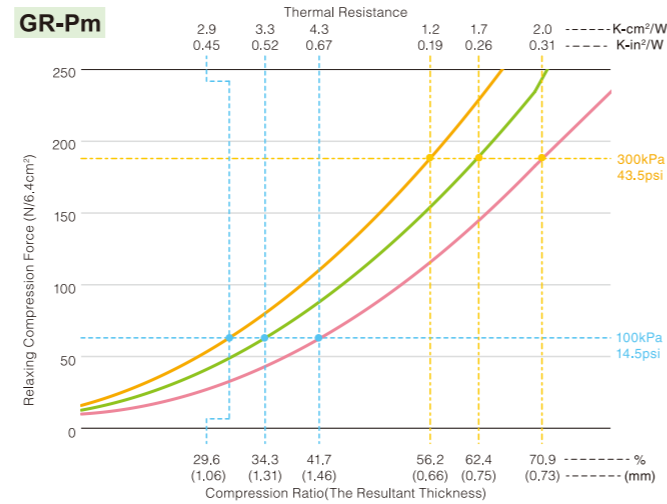
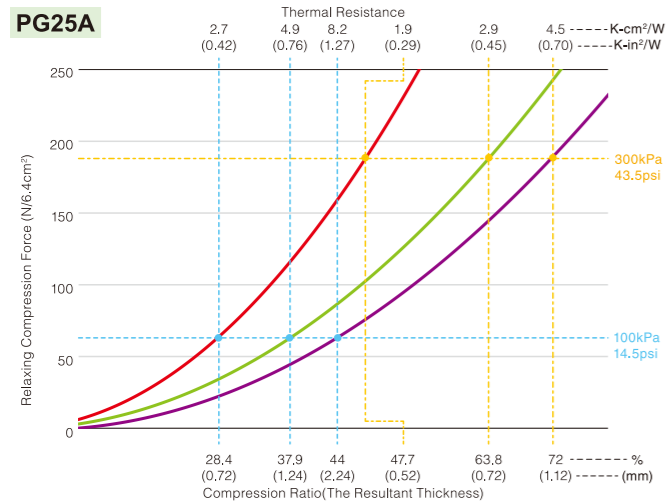
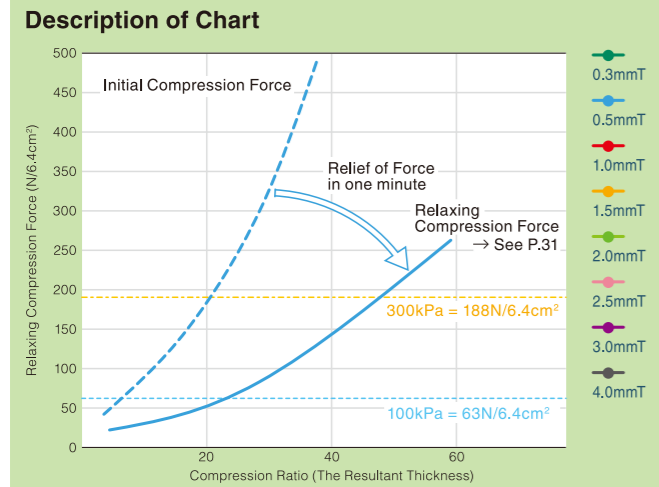

a) Specimen size : for Compression Force : Dia. 28.6mm → See P.46
for Thermal Resistance : Dia. 33.0mm → See P.44
b) The resultant thickness is the gap thickness after relieving of compression force in one minute.
c) ● : Thermal Resistance at 100kPa by using TIM tester ● : Thermal Resistance at 300kPa by using TIM tester

Thickness of SARCON materials

SARCON	Construction	Thickness (mm)	Sheet (mm)
PG25A	PG25A-00-100GY	1.0 ± 0.15	300 x 200 (Recommended Usable Size; 290 x 190)
	PG25A-00-150GY	1.5 ± 0.20	
	PG25A-00-200GY	2.0 ± 0.30	
	PG25A-00-250GY	2.5 ± 0.30	
	PG25A-00-300GY	3.0 ± 0.30	
	PG25A-00-350GY	3.5 ± 0.35	
	PG25A-00-400GY	4.0 ± 0.40	
	PG25A-00-450GY	4.5 ± 0.45	
PG45A	PG45A-00-150GY	1.5 ± 0.25	300x200 (Recommended Usable Size; 290 x 190)
	PG45A-00-200GY	2.0 ± 0.30	
	PG45A-00-250GY	2.5 ± 0.35	

SARCON	Construction	Thickness (mm)	Sheet (mm)
GR-Pm	150G-Pm	1.5 ± 0.5/-0	300 x 200 (290 x 190)
	200G-Pm	2.0 ± 0.7/-0	
	250G-Pm	2.5 ± 0.7/-0	
PG80B	PG80B-00-50RD	0.5 ± 0.10	300 x 200 (Recommended Usable Size; 290 x 190)
	PG80B-00-100RD	1.0 ± 0.15	
	PG80B-00-150RD	1.5 ± 0.25	
	PG80B-00-200RD	2.0 ± 0.35	
PG130A	PG130A-00-30PK	0.3 ± 0.06	300 x 200 (Recommended Usable Size; 290 x 190)
	PG130A-00-50PK	0.5 ± 0.10	
	PG130A-00-100PK	1.0 ± 0.15	
	PG130A-00-150PK	1.5 ± 0.20	
	PG130A-00-200PK	2.0 ± 0.30	

Note: Please do not hesitate to contact with us if you do not see what you need.

FAQ Frequently Asked Questions

SARCON GAP FILLER TYPE (PUTTY SHEET TYPE)

1 What is the maximum thermal conductivity of Putty sheet types?

It is 13.0 W/m-K of SARCON PG130A(Hot Disk method).

2 What is the difference between Putty sheet type and Gel sheet type?

Putty sheet type have excellent conformability and the ability to cover parts with varying heights. Gel sheet type has some resilience and excellent workability.

3 How much pressure/compression is needed for the material to work adequately?

Heat is transferred if there is contact, but we recommend a compression rate of about 30%. (Even if it is compressed by 30% or more, it can be used depending on the load capacity such as heat source.)

4 Will it deform when attached to a component?

As it is a very soft product, it can be deformed.

5 Can Putty sheet types be reused?

We do not recommend reusing Putty sheet type due to the delicate nature of the material.

EM NOISE SUPPRESSION SHEET TYPE

Silicone Gap Filler Pad for Suppression of Electromagnetic Wave

SARCON Noise Suppression sheet type which is silicone gap filler pad for suppression of electromagnetic wave is a highly conformable, high thermally conductive, non-flammable and EM noise suppression materials. They easily fit and adhere to most all shapes and sizes of components, including protrusions and recessed areas.

Features

- Effective to suppress and damp a wide range of electromagnetic waves.
- Also effective as a high performance thermal interface material.
- Easily filling small gaps of IC chip surface with soft gel texture.
- Good workability to simply insert the product between circuit board.
- Self-adhesive gel surface does not require any adhesive tape for assembly.
- Extremely low level of low molecular siloxane.
- UL94 V-0.

Magnetic Characteristics

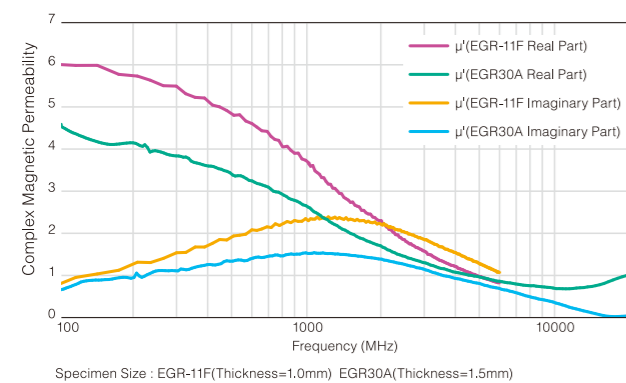

INTRA-DECOUPLING RATIO

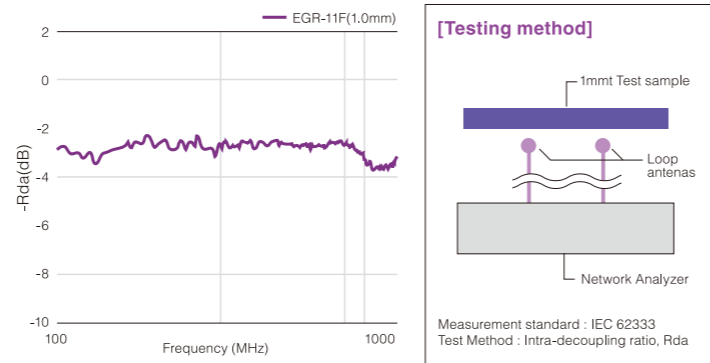

Thickness of SARCON materials

SARCON	Construction	Thickness (mm)	Sheet (mm)
EGR-11F	50EG-11F-0H	0.5 ± 0.15	300 x 200 (Recommended Usable Size; 290 x 190)
	100EG-11F-0H	1.0 ± 0.20	
	150EG-11F-00	1.5 ± 0.20	
EGR30A	EGR30A-0H-50GY	0.5 ± 0.15	
	EGR30A-0H-100GY	1.0 ± 0.2	300 x 200 (Recommended Usable Size; 290 x 190)
	EGR30A-0H-150GY	1.5 ± 0.2	
	EGR30A-0H-200GY	2.0 ± 0.2	
	EGR30A-0H-250GY	2.5 ± 0.3	

Note; Please do not hesitate to contact with us if you do not see what you need.

Compression Force

unit : N/6.4cm² (psi)

C/R	EGR-11F			EGR30A				
	50EG-11F-0H	100EG-11F-0H	150EG-11F-00	0H-50GY	0H-100GY	0H-150GY	0H-200GY	0H-250GY
10%	54 (12.2)	41 (9.3)	48 (10.8)	165 (37.4)	150 (34.0)	147 (33.3)	87 (19.7)	58 (13.1)
20%	288 (65.3)	225 (51.0)	202 (45.8)	442 (100.1)	364 (82.5)	256 (58.0)	179 (40.6)	121 (27.4)
30%	566 (128.2)	422 (95.6)	354 (80.2)	687 (155.6)	524 (118.7)	416 (94.3)	330 (74.8)	221 (50.1)
40%	879 (199.1)	590 (133.7)	521 (118.0)	889 (201.4)	742 (168.1)	640 (145.0)	532 (120.5)	367 (83.1)
50%	1132 (256.5)	813 (184.2)	763 (172.9)	1087 (246.3)	1006 (227.9)	911 (206.4)	771 (174.7)	547 (123.9)
Relaxing	846 (191.7)	408 (92.4)	367 (83.2)	752 (170.4)	693 (157.0)	428 (97.0)	317 (71.8)	193 (43.7)

a) C/R : Compression Ratio
b) Relaxing : Relief of the forth in 1 minute later.
c) Measured by "ASTM D575-91" for reference. → See P.46



Typical Product Properties

Test Properties		Unit	EGR-11F	Test Method	Unit	EGR30A	Test Method
Physical Properties	Thickness*	mm	0.5 to 1.5	ASTM D374	mm	0.5 to 2.5	-
	Specific Gravity	-	3.1	ASTM D792	-	3.6	ASTM D792
	Hardness	Shore OO	56	ASTM D2240	Shore OO	45	ASTM D2240
	Color	-	Dark Gray	Visual	-	Dark Gray	Visual
Electrical Properties	Volume Resistivity	Ohm-m	1x10 ¹⁰	ASTM D257	Ohm-m	2.4x10 ⁹ *1	ASTM D 257
	Breakdown Voltage	V/mm	500	ASTM D149	V/mm	-	-
		(50Hz)	28.33	ASTM D150	(100MHz)	28.30	RF - IV method
		(1kHz)	27.05		(500MHz)	31.60	
	(300kHz)	26.09	(1GHz)	39.10			
	Dissipation Factor	(50Hz)	0.031	ASTM D150	(100MHz)	0.003	RF - IV method
(1kHz)		0.020	(500MHz)		0.044		
(300kHz)		0.005	(1GHz)	0.267			
Thermal Properties	Thermal Conductivity	W/m-K	0.8	Hot Disk : ISO 22007-2	W/m-K	3.0	Hot Disk : ISO 22007-2
	Recommended Operating Temp.	°C	-30 to +120	-	°C	-40 to +120	-
		°F	-22 to +248		°F	-40 to +248	
Flame Retardant	-	V-0	UL94	-	V-0	UL 94	

d) Hardness : the highest value by using Shore OO.
e) Thermal Conductivity : Measured by using Hot Disk method, refer to FUJIPOLY Test method "FTM P-1612". → See P.43
* Some details of thickness. → See P.35
*1 Applied Voltage 100V

Thermal Resistance

unit : K-cm²/W (K-in²/W)

Pressure	EGR-11F		
	50EG-11F-0H	100EG-11F-0H	150EG-11F-00
100kPa /14.5psi	6.8 (1.05)	9.6 (1.49)	12.1 (1.88)
300kPa /43.5psi	6.4 (0.99)	8.8 (1.36)	10.4 (1.61)
500kPa /72.5psi	6.1 (0.95)	8.4 (1.30)	9.7 (1.50)

Pressure	EGR30A			
	0H-100GY	0H-150GY	0H-200GY	0H-250GY
100kPa /14.5psi	2.67 (0.41)	3.52 (0.55)	4.65 (0.72)	5.7 (0.88)
300kPa /43.5psi	2.22 (0.34)	2.92 (0.45)	3.77 (0.58)	4.49 (0.70)
500kPa /72.5psi	1.98 (0.31)	2.48 (0.38)	3.08 (0.48)	3.66 (0.57)

f) Measured by using ASTM D5470 equivalent (TIM tester 1300), refer to FUJIPOLY Test method "FTM P-3050". → See P.44

FAQ Frequently Asked Questions

1 What is the filler that gives the electromagnetic wave suppression characteristics?

The inhibitory effect is given by ferrite and iron powder.

2 Is the EM noise suppression type conductive? (Is the EM noise suppression type an insulator?)

As a product, 10⁸ [Ohm-m] or more is generally regarded as an insulator, but the composition uses conductive ferrite and iron powder.

3 What is the difference between electromagnetic shielding and electromagnetic suppression?

The electromagnetic wave shield is a type that mainly uses the reflection characteristics of electromagnetic waves to prevent electromagnetic waves. The electromagnetic wave suppression (absorption) is a type that converts the energy of electromagnetic waves into heat, and suppresses (absorbs) electromagnetic waves. Electromagnetic wave suppression (absorption) is roughly divided into dielectric loss type and magnetic loss type. Our electromagnetic wave suppression is classified into magnetic loss type. However, it is also called an electromagnetic wave shield by combining electromagnetic wave shield and electromagnetic wave suppression (absorption).

SARCON FORM IN PLACE GAP FILLER TYPE

Highly Thermally Conductive and Electricity Insulative Silicone Compound



SARCON Form in Place Gap Filler Type is a highly conformable / thermally conductive type silicone compound. It provides a thermal solution for the recent trends of higher frequencies and integration in the development of electronic device.

SARCON Form in Place Gap Filler Type easily forms and adheres to most surfaces, shape and size of components.

Features

- Fill large gaps while providing superior thermal transfer.
- Conformable with very low compression forces.
- Excellent vibration absorption capabilities.
- Maintains all initial properties across a wide temperature range.
- Used to "Form-in-Place" and remain form stable.
- Requires no heat curing.
- Will not cause corrosion on any metal surface.

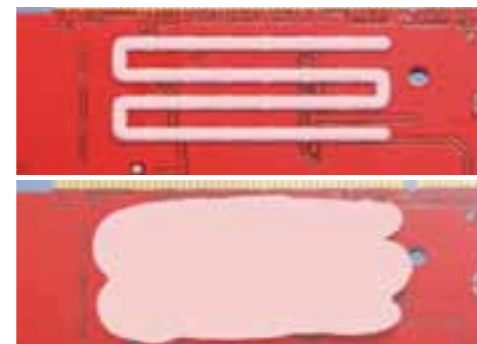

Recommended Application

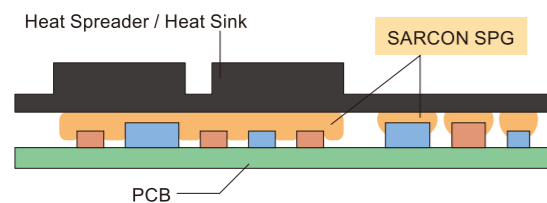

- SARCON Form in Place Gap Filler Type is superior to filling gaps as well as dissipating heat.
- Excellent workability / handling with its softness but no dripping and no pumping.

Packaging Options

- Pre-filled syringe : 30ml
- Caulk Tube : 325ml
- Custom packaging : Available on request

Compression Force

unit : N/6.4cm²(psi)

1.0mm Gap	SPG-20B	SPG-30B	SPG-50A	SPG-70A
0.9mm / 0.035in	10(2.3)	24(5.4)	34(7.7)	25(5.7)
0.8mm / 0.031in	12(2.7)	28(6.3)	38(8.6)	29(6.6)
0.7mm / 0.028in	14(3.2)	34(7.7)	45(10.2)	34(7.7)
0.6mm / 0.024in	17(3.9)	41(9.3)	54(12.2)	42(9.5)
0.5mm / 0.020in	21(4.8)	53(12.0)	69(15.6)	52(11.8)
Relaxing(0.5mm)	3(0.7)	7(1.6)	16(3.6)	4(0.9)

0.5mm Gap	SPG-20B	SPG-30B	SPG-50A	SPG-70A
0.45mm / 0.018in	20(4.5)	53(12.0)	80(18.1)	58(13.1)
0.40mm / 0.016in	22(5.0)	62(14.0)	89(20.2)	63(14.3)
0.35mm / 0.014in	24(5.4)	67(15.2)	100(22.7)	73(16.5)
0.30mm / 0.012in	29(6.6)	82(12.6)	119(27.0)	87(19.7)
0.25mm / 0.010in	33(7.5)	96(21.8)	141(31.9)	109(24.7)
Relaxing (0.25mm)	3(0.7)	10(2.3)	6(1.4)	11(2.5)

a) Relaxing : Relief of the forth in 1 minute later.
b) Measured by "ASTM D575-91" for reference. → See P.46

Compression Load Correlation of FUJIPOLY TIM Pad Products

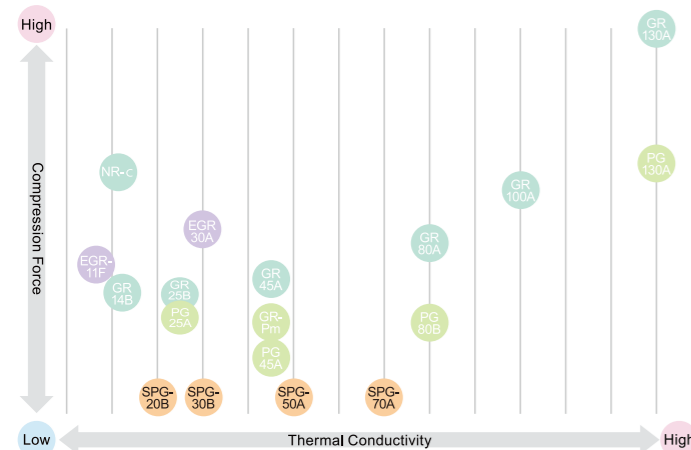

Typical Product Properties

Test Properties		Unit	SPG-20B	SPG-30B	SPG-50A	SPG-70A	Test Method	
Physical Properties	Specific Gravity	-	2.8	3.2	3.2	3.2	ASTM D792	
	Color	-	Light Gray	Apricot	Light Sky Blue	Sky Blue	Visual	
	Viscosity	Pa-s	1.0(1/s)	1,000	2,750	4,100	2,750	ASTM D1824 modified
			0.5(1/s)	1,900	4,600	6,900	4,020	
	Weight Loss	wt%	0.06	0.05	0.06	0.08	FUJIPOLY Original Method	
Consistency	-	330	260	170	184	ASTM D1403		
Electrical Properties	Volume Resistivity	Ohm-m	1x10 ¹³	1x10 ¹²	1x10 ¹²	3.2x10 ⁹	ASTM D257	
	Dielectric Constant	-	50Hz	10.50	10.34	14.85	-	ASTM D150
			1kHz	10.21	10.25	14.61	-	
			1MHz	9.96	10.18	14.27	-	
	Dissipation Factor	-	50Hz	0.0230	0.0065	0.0024	-	ASTM D150
			1kHz	0.0123	0.0042	0.0087	-	
1MHz			0.0056	0.0032	0.0041	-		
Thermal Properties	Thermal Conductivity	W/m-K	2.1	3.1	5.0	7.0	Hot Disk : ISO 22007-2	
	Recommended Operating Temp.	°C	-40 to +150	-40 to +150	-40 to +150	-40 to +150	-	
		°F	-40 to +302	-40 to +302	-40 to +302	-40 to +302		

c) Viscosity: Measured by Modular Advanced Rheometer System RV1 and the specimen flows to 0.5mm Gap between parallel plates. → See P.46
d) Weight Loss at 150°C(302°F) x24hrs , amount of sample: 2cm³ (0.12in³).
e) Thermal Conductivity : Measured by using Hot Disk method, refer to FUJIPOLY Test method "FTM P-1612". → See P.43

FAQ

Frequently Asked Questions

SARCON FORM IN PLACE GAP FILLER TYPE

1 What is the recommended gap distance range?

It depends on the application, but it is recommended to use it with a gap of about 0.3 mm.

2 Can FUJIPOLY recommend dispensing equipment for your application ?

Yes, FUJIPOLY can assist in suggesting the appropriate equipment for dispensing. Please contact us for more details.

3 Does FUJIPOLY offer non-silicone form in place?

Yes, the SPG-NS series is a non-silicone type product. See page 39 for details.

4 What type of packaging is provided?

We can supply syringes, pail cans, cartridges and customised packaging according to the application.

NON-SILICONE FORM IN PLACE GAP FILLER TYPE

Highly Thermally Conductive and Electrically Insulative Silicone free Compound.

SARCON Non-Silicone Form in Place Gap Filler Type is highly conformable and highly thermal conductive type silicone free compound with very low compression force. It provides a thermal solution for the recent trends of higher frequencies and integration in the development of electronic devices. SARCON Non-Silicone Form in Place Gap Filler Type is suitable for filling delicate gaps and still provide superior thermal transfer.

Features

- Suitable for filling delicate gaps and still provide superior thermal transfer.
- Highly conformable with very low compression forces.
- Has excellent vibration absorption capabilities.
- Maintains thermal properties across a wide temperature range.
- Can be used to "Form-In-Place" and will remain form stable.
- Requires no heat curing.
- Will not cause corrosion on any metal surface.
- Silicone free.

Packaging Options

- Syringe : 30cc
- Jar : 1kg
- Custom packaging : Available on request

Typical Product Properties

Test Properties		Unit	SPG-25B-NS	Test method
Physical Properties	Color	-	White	Visual
	Specific Gravity	-	2.5	ASTM D792
	Viscosity	Pa-s	6000	Brookfield
Electrical Properties	Volume Resistivity	Ohm-m	2x10 ¹³	ASTM D257
	Dielectric Constant	-	50Hz	8.31
			1kHz	8.42
			1MHz	8.33
	Dissipation Factor	-	50Hz	0.0002
		1kHz	0.0052	
Thermal Properties	Thermal Conductivity	W/m-K	2.5	Hot Disk : ISO 22007-2
	Recommended Operating Temp.	°C	-40 to +120	-
		°F	-40 to +248	

Viscosity: Measured by Brookfield Viscometer @ 5rpm
Thermal Conductivity: Measured by Hot Disk Test method according to ISO 22007-2.

Applications

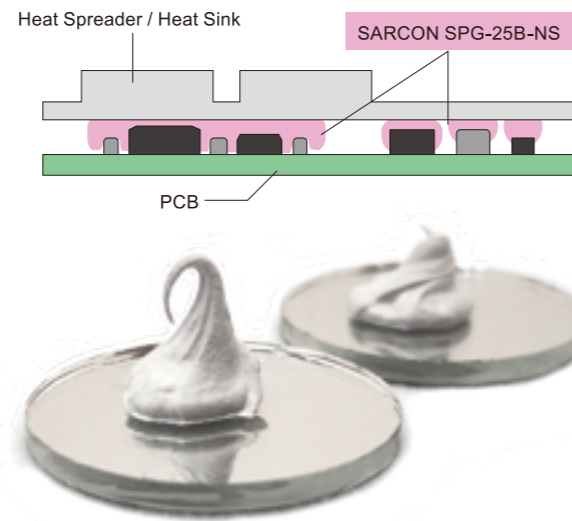

Compression Force

unit : N/6.4cm² (psi)

1.0mm Gap	SPG-25B-NS	0.5mm Gap	SPG-25B-NS
0.9mm / 0.035in	144(32.6)	0.45mm / 0.018in	55(12.4)
0.8mm / 0.031in	214(48.5)	0.40mm / 0.016in	71(16.2)
0.7mm / 0.028in	266(60.3)	0.35mm / 0.014in	92(20.8)
0.6mm / 0.024in	323(73.3)	0.30mm / 0.012in	120(27.3)
0.5mm / 0.020in	391(88.5)	0.25mm / 0.010in	164(37.2)
Relaxing (0.5mm)	11(2.6)	Relaxing (0.25mm)	4(1.0)

Test method: Measured by ASTM D575-91 for reference. → See P.46
 • Specimen Area: DIA.28.6mm (1.13in) • Platens Area: DIA. 28.6mm (1.13in)
 • Sustain: Sustain at 0.5mm/0.25mm for 1 minute
 • Compression Velocity: 5.0mm/minute • Setting Gap : 0.5mm or 1.0mm (Initial Gap)
 • The specimen is pressed till setting a gap, and then waiting for the load to settle down.

THERMALLY CONDUCTIVE GREASE TYPE

Highly Thermally Conductive and Electricity Insulative Compound

SARCON SG-07SL and SG-26SL are highly thermally conductive, non-reactive silicone-based greases that offer low thermal resistance and maintain a nonflowable composition. Unique binding agents and product formulation ensure the lowest amount of bleed and evaporation. Suited for thin bond line applications.

SARCON SG-07NS, SG-26NS and SG-42NS are non-silicone, polysynthetic-based thermal greases that have high thermal conductivity properties. Infused with heat-conductive metal oxides, this nonmigrating material operates consistently in high temperatures. SARCON non-silicone greases offer all the benefits of a silicone-based compound without the problem of contamination.

Features

- Silicone and non-silicone formulations.
- Thermal conductivity up to 4.2 W/m-K.
- Low bleed and evaporation.
- No migration for non-silicone formulations over wide temperature range.
- Non-toxic.
- Thin bond lines 25µm(1mil).
- Easy to apply and re-work.

Applications

- Standard dc/dc power converter and dc/ac inverter
- High performance CPUs
- Between any heat generating semiconductor and heat sink
- Custom power modules
- Telecommunications and automotive electronics

Packaging Options

- Pre-filled syringes : 3cc (6g), 10cc (28g), 30cc (72g)
- Jar containers : 1 lb. (454g)
- Custom packaging : Available on request

Typical Product Properties

Test Properties		Unit	SG-07SL	SG-26SL	SG-07NS	SG-26NS	SG-42NS
Physical Properties	Type	-	Silicone	Silicone	Non-Silicone	Non-Silicone	Non-Silicone
	Specific Gravity, @25°C	-	2.2	2.2	2.4	2.2	2.4
	Color	-	White	Gray	White	Gray	Gray
	Viscosity*	Pa-s	160	406	250	480	502
		Cps	160,000	406,000	250,000	480,000	502,000
	Flow Rate**	g/min	95	6	75	8	6
	Evaporation, @ 200°C, 24hrs.	%Wt	0.52	0.44	0.68	0.5	0.46
Thermal Properties	Thermal Conductivity	W/m-K	0.75	2.6	0.75	2.6	4.2
Electrical Properties	Volume Resistivity	Ohm-cm	2.1x10 ¹⁴	2.8x10 ¹⁴	1.4x10 ¹⁴	2.1x10 ¹⁴	1.8x10 ¹⁴
	Dielectric Strength	kV/mm	15.4	16.5	12.6	15.7	8.8
		volts / mil	386	412	314	392	219
Operating Temperature Range	°C	-55 to 205	-55 to 205	-55 to 200	-55 to 200	-55 to 200	
	°F	-67 to 401	-67 to 401	-67 to 392	-67 to 392	-67 to 392	

* Viscosity Data: Helipath/HB-DV-II+Pro by Brookfield, Speed: 50rpm. ** Flow test: 30cc Syringe, 2.2mm (0.09") orifice at 0.17MPa (25psi).

Volatile Components of SARCON series

1. Volatile Components of Silicone Materials

The volatile materials from silicone elastomers generally include low-molecular siloxane, moisture and cross-linker.

It is very difficult to measure the volume of the moisture or the cross-linker because their amounts in Silicone are too low to be measured. Therefore, we only show the content of low-molecular siloxane.

All silicone elastomers contain some low-molecular siloxane such as D3~D10 (see Fig-1), whose contents are dependent upon each specific manufacturing process or raw materials being used.

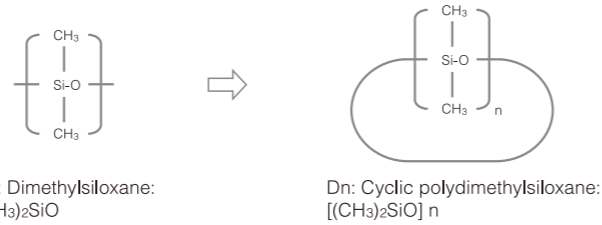

(Fig.1: The low-molecular siloxane chemical formula)

*An electrical contact failure is, in most cases, caused by a high content of the D13 or lower.

*The clouding effect of glass or mirror surface is, in most cases, caused by a high content of siloxane which is greater than D13.

We usually post-cure the product, or use volatility-controlled raw material to reduce low-molecular siloxane to a sufficiently low level. SARCON series is made of the volatility-controlled silicone elastomers.

2. Effect of Low Volatile Siloxane

In the 1980's, there was an electrical defect problem when a motor and a silicone rubber were in closed space or semi closed space. After the investigation, it was found that silica was generated around the electrical contact part due to sparking, and then an electrical defect was caused.

The volatile components of siloxane are cracked by the spark on the motor then the silica is generated.

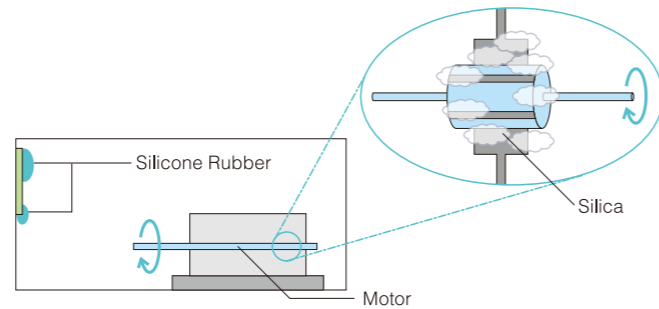

(Fig.2: an electrical defect problem)

3. Contents of Low-molecular Siloxane in SARCON GR•PG•EGR series (D3~D10 by wt%)

[Typical measurement value]

	RTV(General type) ¹	RTV(C.V.type) ²	SARCON GR14B	SARCON GR25B
Dn(wt%) D3~D10	0.2 ~ 1.2	0.01 ~ 0.06	0.0033	0.0010
	SARCON GR45A	SARCON GR80A	SARCON GR100A	SARCON GR130A
	0.0010	0.0010	0.0010	0.0010
	SARCON PG25A	SARCON PG45A	SARCON GR-Pm	SARCON PG80B
	0.0015	0.0010	0.0010	0.0010
	SARCON PG130A	SARCON EGR-11F	SARCON EGR30A	SARCON SPG-20B
	0.0010	0.0010	0.0010	0.0010
	SARCON SPG-30B	SARCON SPG-50A	SARCON SPG-70A	
0.0010	0.0016	0.0010		

*1 RTV : Room Temperature Vulcanizing silicone rubber *2 C.V. : Controlled Volatility type

Bellcore Test

• Reference: Bellcore TR-NWT-000930, section 10.3

• Results:

Material	Extractable Residue (%)	TR-NWT-000930 ¹
TR	2.07	Pass
HR	1.26	Pass
YR-a	1.23	Pass
YR-d	4.23	Pass
GR14B	15.22	Pass
GR25B	6.70	Pass
GR45A	4.73	Pass
GR80A	4.02	Pass
PG25A	8.25	Pass
GR-Pm	6.60	Pass
PG130A	4.22	Pass
EGR-11F	8.07	Pass
EGR30A	6.05	Pass

• Method:

Between one and five grams of each submitted sample was cut into small sections before being placed into a clean, pre-weighed flask labeled "Sample Flask" along with 100mL of hexane. The flask was then stoppered up for a period of at least twelve hours. The solution from this initial flask was then poured into a second clean and pre-weighed flask labeled "Residue Flask" which was then placed into a water bath at 80°C for one hour to distill off the hexane. Upon completion of the water bath exposure, all sets of the flasks were baked in an oven for one hour at 100°C to ensure the complete evaporation of the hexane. The final mass of each flask was then recorded such that an amount of "extractable" silicone could be calculated for each sample.

(Note: Any extracted "mass" was assumed to be silicone.)

¹ The extractable residue shall be less than 7 weight percent; or less than 18 weight percent if the viscosity of the residue is greater than 1,000 cp. The requirements are based on room temperature extraction in hexane.

• Soxhlet Extraction Test : (FUJIPOLY Original)

Material	Extractable Residue(wt %)
GR130A	5.20
GR100A	4.20
PG45A	2.20
PG80B	4.20

Unmeasurable silicone oil content of GR130A,PG45A,PG80B by Bellcore Test. Therefore these are measured by FUJIPOLY Original Soxhlet Extraction with toluene, extraction time for twenty-four hours.

Outgas Test

• Reference: ASTM E595

• Results:

Material	Total Mass Loss (%)	Collected Volatile Condensable Material (%)	Water Vapor Recovered (%)
TR	0.19	0.03	0.04
HR	0.16	< 0.01	0.03
YR-a	0.09	< 0.01	0.02
YR-d	0.10	0.03	0.03
GR14B	0.25	0.11	0.02
GR25B	0.30	0.01	0.01
GR45A	0.04	0.02	0.03
GR80A	0.07	< 0.01	0.03
GR100A	0.06	< 0.01	0.03
GR130A	0.10	0.02	0.02
PG25A	0.11	0.01	0.03
PG45A	0.04	0.04	0.04
GR-Pm	0.09	0.03	0.02
PG80B	0.10	0.03	0.01
PG130A	0.10	0.04	0.02
EGR30A	0.08	< 0.01	0.03

• Method:

Random areas were carefully removed from the test specimen and weighed. The specimen was placed in a preformed, degreased container (boat) and was then conditioned at 23°C and 50% relative humidity for 24 hours. After conditioning, the boat and the specimen were weighed and placed in the specimen compartment in a copper heating-bar that is part of the test apparatus. The copper heating-bar was then placed in the vacuum chamber, which was then sealed. The vacuum chamber was evacuated to a vacuum of at least 5.0 x 10⁻⁵ torr. The heating-bar was raised to a temperature of 125°C. This caused the vapor from the heated specimen to stream from the hole in the specimen compartment. The vapor passed through the collector chamber where the vapor condensed on a previously-weighed and independently temperature-controlled, chromium-plated collector plate that was maintained at 25°C. After 24 hours, the test apparatus was cooled and the vacuum chamber was then re-pressurized with a dry, inert gas. The specimen and the collector plates were weighed. The TML and CVCM percentages were then determined. After the specimen was weighed to determine the TML, the WVR was determined by conditioning the specimen at 23°C with 50% relative humidity for 24 hours. The specimen was again weighed and the WVR was calculated.

Test method

Test Method of Thermal Conductivity by ISO 22007-2 FUJIPOLY standard

FUJIPOLY Test Method: FTM P-1612 (Hot Disk method)

1. Method

The probe of which the thermal conductivity is known is put on the specimen. Then the hot wire is given constant electric power.

2. Principle

A thermal conductivity is given by the equation below.

$$\lambda = \frac{P_0 \cdot D(\tau)}{\pi^{3/2} \cdot r} \cdot \frac{D(\tau)}{\Delta T(\tau)}$$

λ : Thermal Conductivity (W/m-K)

P_0 : Electric Power (W)

r : A Radius of Sensor (m)

τ : $\sqrt{\alpha \cdot t / r^2}$

α : Thermal Diffusivity (m²/s)

t : Measurement Time (s)

$D(\tau)$: Function of τ

$\Delta T(\tau)$: Temperature Increase of Sensor (K)

3. Apparatus

Thermal Conductivity meter	TPS-2500
Sensor	RTK Polyimide

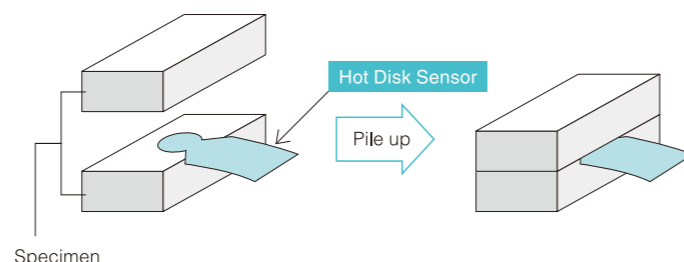

Thermal conductivity is calculated by software for calculation.

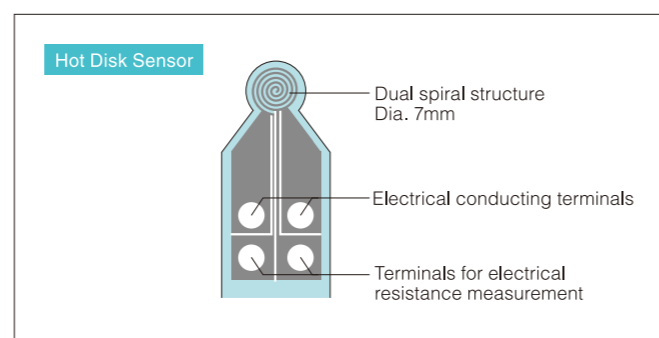

Test Method of Thermal Conductivity by ASTM D2326

FUJIPOLY Test Method: FTM P-1620 (Hot Wire method)

1. Method

The probe of which the thermal conductivity is known is put on the specimen. Then the hot wire is given constant electric power.

Thermal conductivity is calculated by software for calculation.

Specimen : Thickness -- 0.1 to 2.0 mm

Width x Length -- Min. 120 x 60 mm

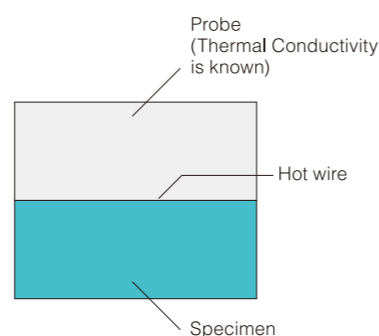

2. Principle

A thermal conductivity is given by the equation below.

$$\lambda = \frac{Q \ell n(t_2/t_1)}{4\pi \cdot (T_2 - T_1)}$$

λ : Thermal Conductivity(W/m-K)

Q : Quantity of Transferred heat (W/m)

T_1, T_2 : Temperature at times t_1 and t_2 (K)

t_1, t_2 : Measurement Time (s)

3. Apparatus

Thermal Conductivity meter	QTM-D3
Calculator	PC9801BX2
Probe	QTM-PD1

Temperature Excursion

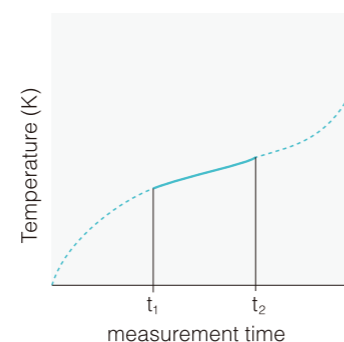

Test Method of Thermal Resistance by ASTM D5470 FUJIPOLY standard

FUJIPOLY Test Method: FTM P-3050 (TIM Tester method)

1. Principle

Thermal Resistance

$$R_t = \frac{T_1 - T_2}{Q} \cdot S$$

R_t : Thermal Resistance (K-cm²/W)

T_1 : Heater temperature (K)

T_2 : AL cooling plate temperature (K)

Q : Heat flow (W)

S : Area of the compressed specimen (cm²)

2. Measuring Equipment

Analysis Tech TIM Tester 1300

The Analysis Tech TIM Tester 1300 automatically includes the overall estimated accuracy with the thermal impedance data. This measuring equipment conforms to the test method ASTM D5470, Thermal Transmission Properties of Thermally Conductive Electrical Insulation Materials with the most recent revision.

The measurement by the load

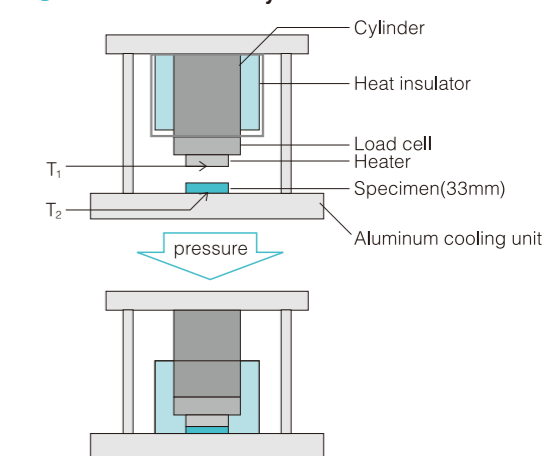

Test Method of Thermal Resistance and Thermal Conductivity by ASTM D5470 modified

FUJIPOLY Test Method: FTM P-3030 (Guarded Hot Plate method for reference)

1. Principle

Thermal Resistance

$$R_t = ((T_1 - T_2) \cdot S / Q) - 0.34$$

R_t : Thermal Resistance (K-cm²/W)

T_1 : AL heating plate temperature (K)

T_2 : AL cooling plate temperature (K)

Q : Heat flow (W)

S : Area of the compressed specimen (cm²)

0.34 : Thermal resistance revision value of AL plate

Thermal Conductivity

$$\lambda = \frac{T_3 - T_4}{R_{T3} - R_{T4}}$$

λ : Thermal Conductivity (W/m-K)

T_3 : Thickness of Specimen 1 (cm)

T_4 : Thickness of Specimen 2 (cm)

($T_3 > T_4$)

R_{T3} : Thermal Resistance of Specimen 1 (K-cm²/W)

R_{T4} : Thermal Resistance of Specimen 2 (K-cm²/W)

The measurement by the quantity of compression

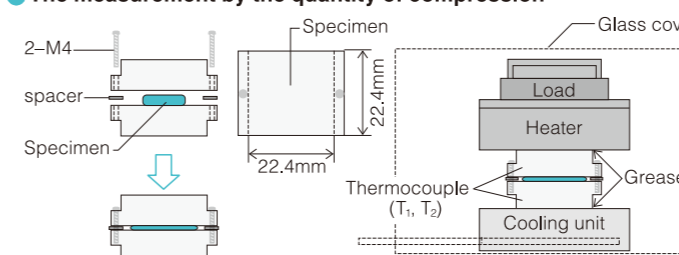

The measurement by the load

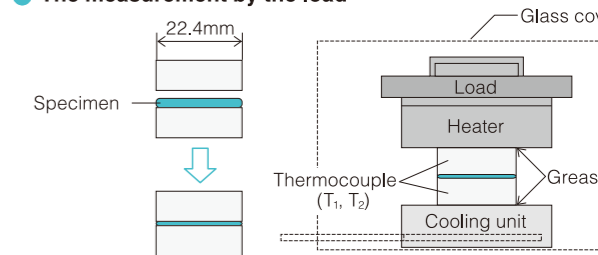

Test Method of Thermal Resistance by ASTM D5470 modified

FUJIPOLY Test Method: FATM P-3031

1. Method

The sample is placed between the metal blocks as shown in Figure 1.

The spacer is placed between the metal blocks, A screw is used to compress the sample to the thickness of the spacer.

The thermal resistance is calculated from the following expressions.

2. Principle

Aluminum boards : $R_t = (\Delta T \cdot S / Q)$

R_t : Thermal Resistance (K-cm²/W)

Q : Applied power (W)

ΔT : Top and bottom metal board temperature difference $T_1 - T_2$ (K)

S : Sample contact area(cm²)

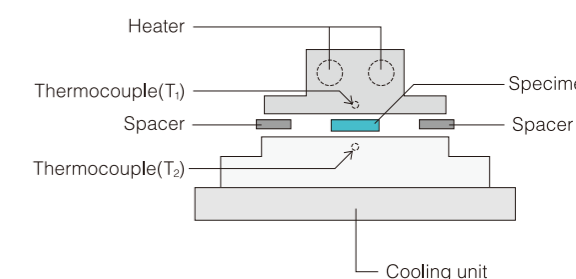

Test method

Test Method of Thermal Resistance by ASTM D5470 modified FUJIPOLY original

FUJIPOLY Test Method: FTM P-3070

1. Test Method

FUJIPOLY test method FTM P-3070 which gives ASTM D5470 equivalent value. The sample is sandwiched between aluminum blocks with thermocouples installed, screwed with a specified torque, constant power is applied to the heater to generate constant heat, and the thermal resistance value is measured from the temperature difference between the upper and lower thermocouples.

2. Principle

A thermal impedance is given by the equation below.

$$R_t = (T_c - T_f) \times S / P_0$$

- R_t : Thermal resistance (K-cm² / W)
- T_c : T₁ temperature (K)
- T_f : T₂ temperature (K)
- S : Sample installation area (cm²)
- P₀ : Electric power (W)

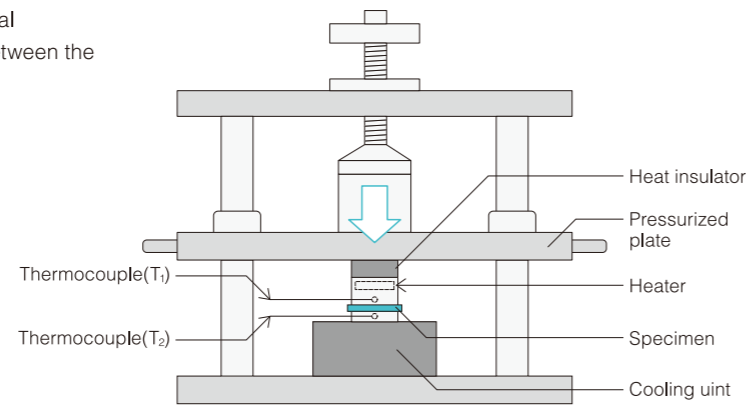

Test Method of Compression Force by ASTM D575-91

1. Test Method

Compression test in which the force required to cause a specified deflection is determined.

2. Test Condition

Specimen	Dia.28.6mm (1.13in) Thickness is according to each materials
Platens	Dia.28.6mm (1.13in) Number of specimens; 3pcs
Compression Speed	5.0mm/min (0.2in/min) *FUJIPOLY original speed

[Note]

Measuring Form in Place Gap Filler type:

The specimen is pressed till setting a gap, and then waiting for the load to settle down.

Setting a gap: 0.5mm or 1.0mm.

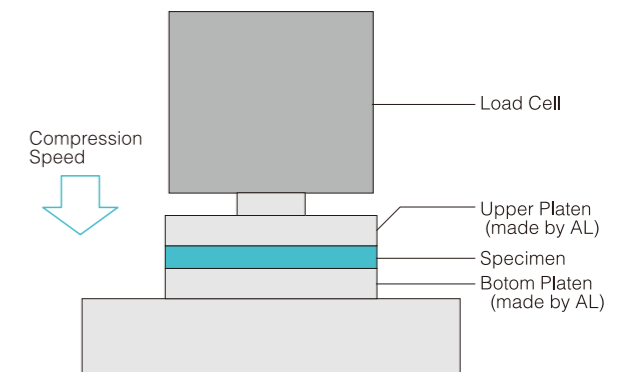

Test Method of Viscosity by ASTM D1824 - 95(2010) modified

1. Test Method

Covers the measurement of SARCON's viscosity at low shear rates.

2. Apparatus

Equipment	HAAKE RotoVisco 1
Sensor	C20/2
Clearance Gap	0.5mm
Rotational Speed	0.5(1/s), 1.0(1/s)

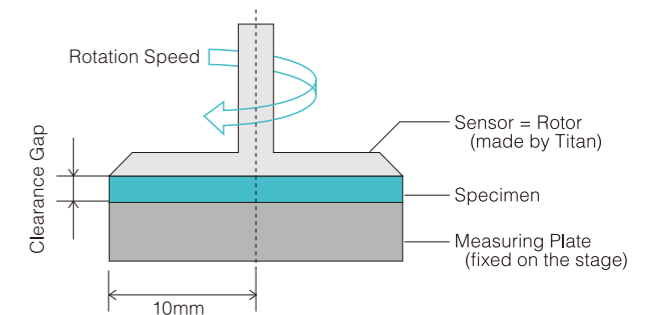

FUJIPOLY Technology

Silicone rubber extrusion technology

Silicone rubber is a unique material that has excellent temperature resistance, electrical insulation, and is chemically stable.

FUJIPOLY specialises in the formulation of silicone rubber technology that meets customer requirements.

Furthermore, we have the technical knowledge to offer customised solutions.

We will introduce extrusion molding technology that FUJIPOLY excels at. Extrusion molding is a method of continuously extruding materials to form the same shape, as shown below.

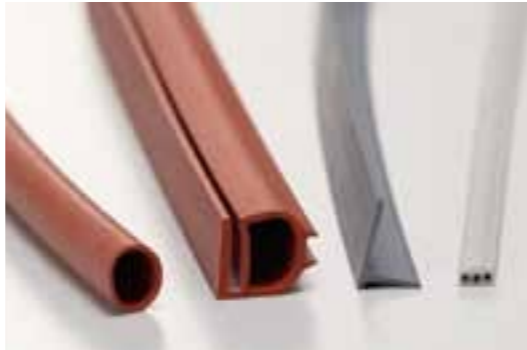

Material

If the material is of a general silicone rubber, you can select the colour and hardness. Depending on the formulation, it is possible to modify the values of heat transfer, as well as electrical conductivity.

Shape

As shown in the picture below, it is possible to produce customised shapes by the fitting of extrusion molding tools to the ejection port. By using our co-extrusion technology, it is possible to extrude materials with different properties at the same time. An application of a co-extrusion could be the combination of electrically conductive and insulating materials, producing a switch.

Irregular shape/ Tube / Rod / Sheet



Co-extrusion

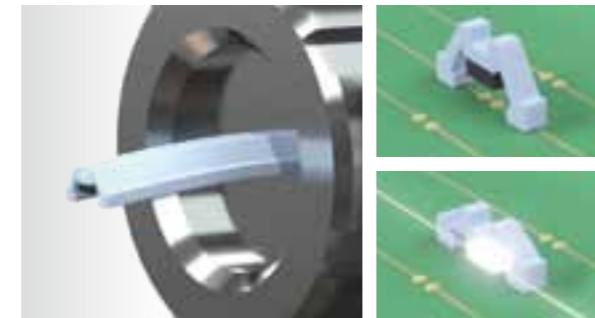

It is also possible to use our extrusion materials as packing by the use of adhesion to the end faces.



SARCON and the use of Automated Robotic Systems

In recent years, the automotive industry has adopted artificial Intelligence (AI) and the Internet of Things (IOT) in the automation process within manufacturing plant.

In the field of automation, SARCON products have been used successfully, working together with manufacturers and system integrators, accumulating knowledge and experience.

Benefits of automatic implementation

- Significant improvement in position/accuracy
- Reduction of contamination risk
- Labour saving



*In the case of Reel (Sheet)

automatic mounting using a robot arm

GR14B (GEL SHEET TYPE) 3mmt 20x20

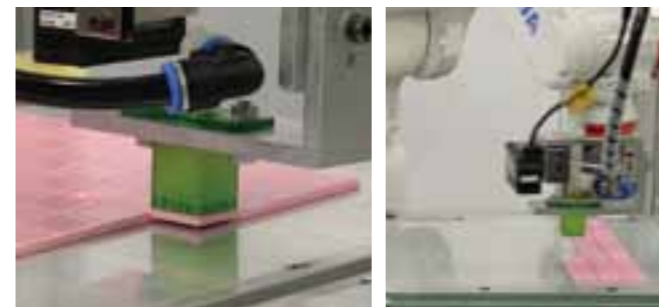

PG25A (PUTTY SHEET TYPE) 3.5mmt Irregular shape

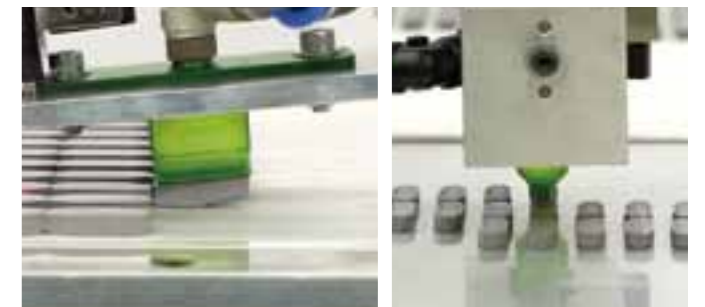

PG80B (PUTTY SHEET TYPE) 0.5mmt 8x6



SPG-30B



Robot hand must be created according to product and shape.



Note:

* It may not be possible to use automated systems on some materials.

* FUJIPOLY does not sell automated robotic systems or peripherals, however we work with manufacturers and system integrators to assist you in the automation process.

ZEBRA Features

- High Density, increased number of I/O's
- Low resistance, high current capacity
- Low insertion force, low compression force
- Redundant contact engagement
- High electrical and mechanical reliability
- Chemical stability, degradation resistance
- Cost-effectiveness, ease of assembly



ZEBRA CARBON / SILVER CONNECTOR SERIES

ZEBRA elastomeric connectors are constructed of alternating parallel layers of electrically conductive and non-conductive silicone elastomer. ZEBRA provides a redundant connection with a minimum of two conductive layers recommended per PC contact pad. The connector is available with insulating barrier or silicone supports.

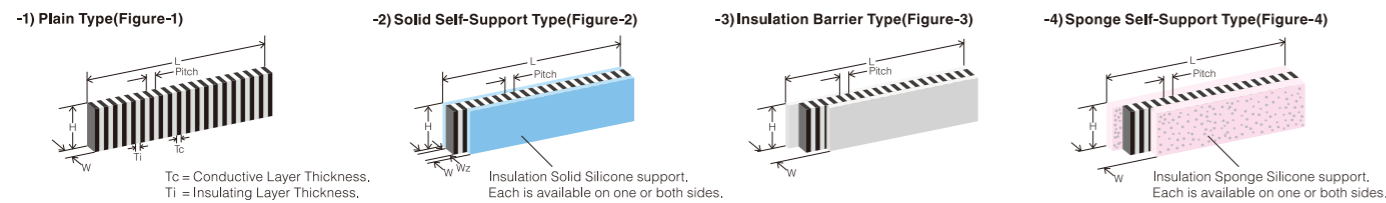

		CZ405/CZ705/2005	CZ410/CZ710/1002	CZ418/2004	SZ100/5002
Metal Particles for Conductive Layers		Carbon	Carbon	Carbon	Silver
Contact Area Pitch: Contact Spacing Center-to-Center	Minimum	0.25mm 0.010in.	0.38mm 0.015in.	0.50mm 0.020in.	0.38mm 0.015in.
Pitch (Ti+Tc):	Normal	0.050mm 0.002in.	0.10mm 0.004in.	0.18mm 0.007in.	0.10mm 0.004in.
Sum of the Thickness of an Adjacent Conductive and Non-conductive Layer	Maximum	0.10mm 0.004in.	0.15mm 0.006in.	0.25mm 0.010in.	0.152mm 0.006in.
Conductive Layers	Minimum	160/10mm 500/in.	88/10mm 240/in.	45/10mm 140/in.	66/10mm 240/in.
Individual Conductive and Insulating Layer Thickness	Minimum	0.010mm 0.0004in.	0.025mm 0.001in.	0.050mm 0.002in.	0.025mm 0.001in.
Contact Area Pitch: Contact Spacing Center-to-Center	Maximum	0.060mm 0.0024in.	0.10mm 0.004in.	0.15mm 0.006in.	0.075mm 0.003in.
Available Lengths	Maximum	230mm 9.0in.	230mm 9.0in.	230mm 9.0in.	127mm 5.0in.
Length (L)		4.0 to 61.0mm : ±0.20mm 61.2 to 152.4mm : ±0.38mm 152.6 to 200.0mm : ±0.50mm 200.1 to 230.0mm : ±1.00mm	0.157 to 2.40in. : ±0.008in. 2.41 to 6.00in. : ±0.015in. 6.01 to 7.87in. : ±0.02in. 7.88 to 9.00in. : ±0.039in.		6.35±0.12 to 127.0±0.64mm 0.25±0.005 to 5.0±0.025in.
Height (H)		0.5 to 19.0mm : ±0.127mm above 19.0mm / 0.75in. Consult factory	0.02 to 0.75in. : ±0.005in.		1.0±0.08 to 12.7±0.18mm 0.04±0.003 to 0.5±0.07in.
Width (W)		0.38 to 1.0mm : ±0.05mm 1.01 to 2.0mm : ±0.076mm 2.01 to 3.0mm : ±0.127mm above 3.0mm / 0.118in. Consult factory	0.015 to 0.039in. : ±0.002in. 0.040 to 0.079in. : ±0.003in. 0.080 to 0.118in. : ±0.005in.		0.5±0.08 to 2.54±0.13mm 0.02±0.003 to 0.1±0.005in.
Temperature Range		-40 to +100°C -40 to +212°F			-40 to +185°C -45 to +80°F
Current Carrying Capacity		0.005A/mm ² pad 0.005A/0.04"x0.04" pad			0.3A/mm ² pad 0.3A/0.04"x0.04" pad
Resistance Between Layers		10 ⁻⁹ ohms			

RESISTANCE - To calculate the resistance of ZEBRA connectors, choose one of the following formulas:

For Carbon ZEBRA		For Silver ZEBRA		Where:
Metric:	$R = \frac{60 \times H}{E_w \times W}$	Metric:	$R = \frac{H \times 0.01}{W \times E_w} + 0.1$	
Inches:	$R = \frac{2.37 \times H}{E_w \times W}$	Inches:	$R = \frac{H \times 0.0004}{W \times E_w} + 0.1$	

ZEBRA GOLD 8000 CONNECTORS

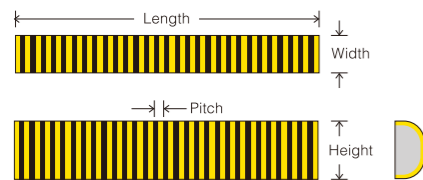

ZEBRA Series 8000 elastomeric connector elements are D-shaped, low durometer silicone elastomers cores around which flat metallic gold-plated conductors are vulcanized in a row parallel to each other. The tips of the metallic conductors are turned upward so that point contact can be effected; in addition, contact is made to the flat area when the connector element is positioned between two printed circuit boards. The point contact will penetrate surface oxides or contaminants which might be present on the surface of the contact pads.



LOCATIONS



Fuji Polymer Industries Co., Ltd.

Head office / Sales Department
FUJIPOLY Bldg., 5-21-1, Meieki, Nakamura-ku, Nagoya, Aichi 450-0002 JAPAN
Phone : +81-52-589-9251 Fax : +81-52-589-9311
e-mail : sales@fujipoly.co.jp
Web site : https://www.fujipoly.co.jp/

Nagoya sales office Scheduled to relocate in December 2022.
FUJIPOLY Bldg., 5-21-1, Meieki, Nakamura-ku, Nagoya, Aichi 450-0002 JAPAN
Phone : +81-52-589-9252 Fax : +81-52-589-9311

Tokyo sales office
7F Kanda KYU Building, 1-9-4, Kaji-cho, Chiyoda-ku, Tokyo 101-0044 JAPAN
Phone : +81-3-5207-6111 Fax : +81-3-5207-6114

Osaka sales office
7F New Osaka 2nd Doi Building, 2-14-6, Nishinakajima, Yodogawa-ku, Osaka 532-0011 JAPAN
Phone : +81-6-6304-8287 Fax : +81-6-6304-8477

Aichi Factory
175 Kajiyashiki, Toyota, Aichi 4700533 JAPAN
Phone : +81-565-65-2121 Fax : +81-565-65-2266
e-mail : sales@fujipoly.co.jp
Web site : https://www.fujipoly.co.jp/
ISO9001

Technical Center
510 Yabuta-cho, Moriyama-ku, Nagoya, Aichi 463-0026 JAPAN
Phone : +81-52-768-1581 Fax : +81-52-768-1587
e-mail : sales@fujipoly.co.jp
Web site : https://www.fujipoly.co.jp/

FUJIPOLY Taiwan Co., Ltd.

Room B, 7F., No. 59, Tiansiang Rd., Zhongshan District, Taipei City 10452, Taiwan
Phone : +886-2-2586-5771 Fax : +886-2-2586-5745
Web site : http://www.fujipoly.com.tw/
E-mail : fujipolytw@fujipoly.com.tw

FUJIPOLY (Thailand) Co., Ltd.

55/8 Moo 13 Navanakorn Industrial Estate Phase 4, Phaholyothin Road, Klong Nueng, Klong Luang, Pathumthanee 12120, Thailand
Phone : +66-2-529-2732 Fax : +66-2-529-2223
E-mail : marketing@fujipoly.co.th

Fuji Polymer Industries Co., Ltd. Korea Liaison Office

A-404, 97 Yeouidong-ro, Youngdeungpo, Seoul, 07324, Korea
Phone : +82-2-785-2801 Fax : +82-2-785-2802
Web site : https://fujipoly.co.kr/
E-mail : info@fujipoly.co.kr

FUJIPOLY Singapore Pte Ltd.

1001 Jalan Bukit Merah #02-17/20 Singapore 159455
Phone : +65-6272-3766 Fax : +65-6272-3577
Web site : https://www.fujipoly.sg
E-mail : info@fujipoly.com.sg

FUJIPOLY America Corporation

900 Milik Street P.O. BOX 119 Carteret, NJ 07008-0119, USA
Phone : +1-732-969-0100 Fax : +1-732-969-3311
Web site : https://www.fujipoly.com/
E-mail : info@fujipoly.com

FUJIPOLY Hong Kong Ltd.

Workshop(F&J), Block 1, 4/F, Kwai Tak Industrial Centre, 15-33 Kwai Tak Street, Kwai Chung, N.T., Hong Kong.
Phone : +852-2428-3770 Fax : +852-2489-9637
E-mail : info@fujipoly.com.hk

FUJIPOLY Customer Engineering Resource Center

94 Bonaventura Drive, San Jose, CA, 95134
Phone : +1-408-708-5980
E-mail : fpcerc@fujipoly.com

FUJIPOLY Trading (Shenzhen) Co., Ltd.

Room 2703, Diwang Commercial Building, Shunhing Square, 5002 Shennan East Road, Luohu District, Shenzhen, 518022, China
Phone : +86-755-8237-5494 Fax : +86-755-8237-5491
Web site : http://www.fujipoly.net.cn
E-mail : info@fujipoly.com.hk

FUJIPOLY Europe Ltd.

Avant Business Centre, Unit 8, Third Avenue, Bletchley Milton Keynes, MK1 1DR UK
Phone : +44-1908-277800 Fax : +44-1908-277900
Web site : https://www.fujipoly.eu/
E-mail : sales@fujipoly.eu

FUJIPOLY Europe Ltd. Germany Liaison Office

Phone : +49-7156-9278310
Web site : https://www.fujipoly.eu/
E-mail : support.germany@fujipoly.eu

FUJIPOLY China (Dongguan) Electronics Co., Ltd.

Gaobao Road 10, Tutang Estate, Changping, Dongguan, Guangdong, 523581, China
Phone : +86-769-8398-9660 Fax : +86-769-8398-9662
E-mail : info@fujipoly.com.hk